

# Technics

CD Stereo System

## SC-CH700

### OPERATING INSTRUCTIONS

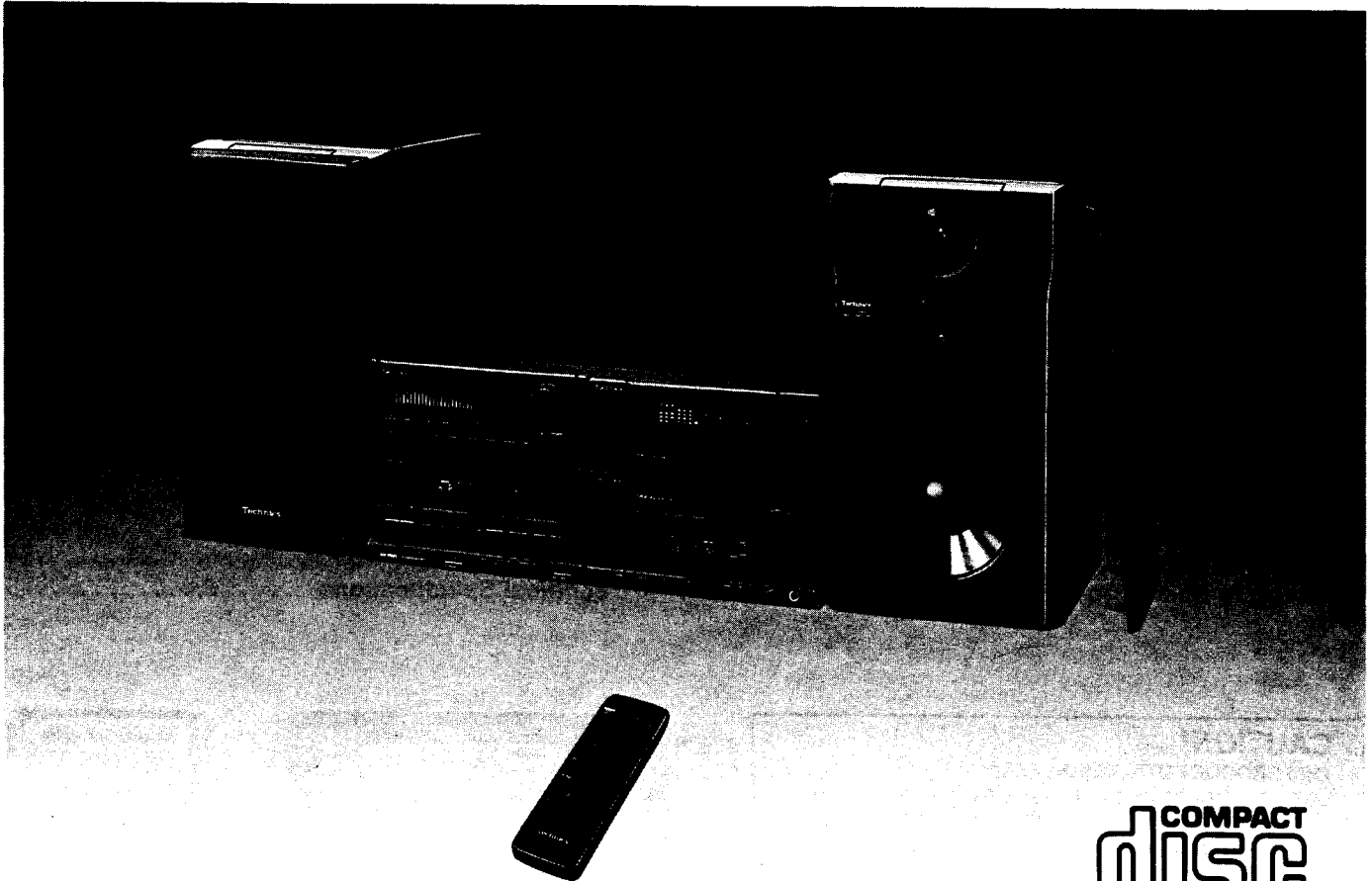

COMPACT  
**disc**  
DIGITAL AUDIO

**Notes:**

- Specifications differ according to the area code.
- The "EB" area code, for example, indicates United Kingdom specifications.
- The "EB" indication is shown on the packing case and serial number tag.

Before operating this unit, please read these instructions completely.

## Dear Stereo Fan

We want to thank you for selecting this product and to welcome you to the growing family of satisfied Technics product owners around the world. We feel certain you will get maximum enjoyment

from this new addition to your home. Please read these operating instructions carefully, and be sure to keep them handy for convenient reference.

These operating instructions are applicable to the following systems.

System	CD player/Tuner	Amplifier	Sound processor	Cassette deck	Speakers
SC-CH700	SL-CH700	SU-CH700	SH-CH700	RS-CH700	SB-CH700

# Table of Contents

Suggestions for Safety .....	3	Making a Recording .....	41
For United Kingdom .....	3	Edit-Recording from Compact Discs .....	45
Placement Notes .....	4	Tape-to-Tape Recording .....	52
Supplied Accessories .....	4	Using the Timer .....	53
Concerning the Remote Control .....	5	Creating Your Own Sound .....	58
How to Install the System .....	6	Enjoying the Microphone Mixing .....	67
Connections .....	7	Using an External Unit .....	69
Front Panel Controls and Functions .....	14	Concerning the Display .....	70
Basic Operating Procedure .....	24	Concerning Cassette Tapes .....	71
Setting the Time .....	27	Concerning Compact Discs .....	72
Listening to Compact Discs .....	28	Maintenance .....	73
Listening to Tapes .....	34	Troubleshooting Guide .....	74
Listening to Radio Broadcasts .....	38	Technical Specifications .....	76

### CAUTION!

THIS PRODUCT UTILIZES A LASER. USE OF CONTROLS OR ADJUSTMENTS OR PERFORMANCE OF PROCEDURES OTHER THAN THOSE SPECIFIED HEREIN MAY RESULT IN HAZARDOUS RADIATION EXPOSURE. DO NOT OPEN COVERS AND DO NOT REPAIR YOURSELF. REFER SERVICING TO QUALIFIED PERSONNEL.



(Back of product)

**DANGER-Invisible laser radiation when open. AVOID DIRECT EXPOSURE TO BEAM.**

(Inside of product)

THIS TUNER/RECEIVER IS CAPABLE OF RECEIVING THE NEW AM STEREO BROADCASTS FROM THE AM BAND RADIO STATIONS. HOWEVER LIKE MANY TUNERS AND RECEIVERS CURRENTLY AVAILABLE ON THE MARKET IT WILL REPRODUCE THIS AM STEREO SIGNAL ONLY IN AM MONO, WHICH, IN EFFECT, IS OF NO LESSER QUALITY THAN YOUR EXISTING AM MONO TUNER/RECEIVER.

# Suggestions for Safety

## ■ Use a standard AC wall outlet

1. **Use from an AC power source of high voltage, such as that used for an air conditioner, is very dangerous.**

There is a possibility that a fire might be caused by making such a connection.

2. **A DC power source cannot be used.**

Be sure to check the power source carefully, especially on a ship or other place where DC is used.

## ■ Grasp the plug when disconnecting the power supply cord

1. **Wet hands are dangerous.**

A dangerous electric shock may result if the plug is touched by wet hands.

2. **Never place heavy items on top of the power supply cord, and never force it to bend sharply.**

## ■ Place the unit where it will be well ventilated

Place this unit at least 10 cm (4") away from wall surfaces, etc.

Be careful that curtains and similar materials do not obstruct the ventilation holes.

## ■ Avoid places such as the following:

**In direct sunlight or in other places where the temperature is high.**

**In places where there is excessive vibration or humidity.**

Such conditions might damage the cabinet and/or other component parts and thereby shorten the unit's service life.

## ■ Be sure to place the unit on a flat, level surface.

If the surface is inclined, a malfunction may result.

## ■ Never attempt to repair or reconstruct this unit

A serious electric shock might occur if this unit is repaired, disassembled or reconstructed by unauthorized persons, or if the internal parts are accidentally touched.

## ■ Take particular care if children are present

Never permit children to put anything, especially metal, inside this unit. A serious electric shock or malfunction could occur if articles such as coins, needles, screwdrivers, etc. are inserted through the ventilation holes, etc. of this unit.

## ■ If water is spilled on the unit

Be extremely careful if water is spilled on the unit, because a fire or serious electric shock might occur. Immediately disconnect the power cord plug, and consult with your dealer.

## ■ Avoid spray-type insecticides

Insecticides might cause cracks or "cloudiness" in the cabinet and plastic parts of this unit. The gas used in such sprays might, moreover, be ignited suddenly.

## ■ Never use alcohol or paint thinner

These and similar chemicals should never be used, because they might cause flaking or cloudiness of the cabinet finish.

## ■ Disconnect the power supply cord if the unit will not be used for a long time

If the unit is left for a long time with the power ON, this will not only shorten its useful operation life, but may also cause other trouble.

## ■ If trouble occurs

If, during operation, the sound is interrupted or indicators no longer illuminate, or if an abnormal odour or smoke is detected, immediately disconnect the power cord plug, and contact your dealer or an Authorized Service Center.

# For United Kingdom

("EB" area code model only)

The "EB" indication is shown on the serial number tag.

## Important

THE WIRES IN THIS MAINS LEAD ARE COLOURED IN ACCORDANCE WITH THE FOLLOWING CODE.

BLUE: NEUTRAL

BROWN: LIVE

As the colours of the wires in the mains lead of this apparatus may not correspond with the coloured markings identifying the terminals in your plug proceed as follows. The wire which is coloured BLUE must be connected to the terminal which is marked with the letter N or coloured BLACK.

The wire which is coloured BROWN must be connected to the terminal which is marked with the letter L or coloured RED.

Under no circumstances must either of the above wires be connected to the earth terminal of a three pin plug.

This apparatus was produced to BS 800.

# Placement Notes

■ This unit is a precision instrument. Be sure to place it on a flat surface.

■ Avoid places such as the following:

- Near any equipment or device that generates strong magnetism.
- On any heat-generating equipment or device, or in any place where the temperature is high (35°C 95°F or higher).
- Extremely cold places (5°C 41°F or below).
- For long periods of time in direct sunlight.
- In dusty or smoky locations.
- In locations prone to vibrations.
- In locations where the rear panel is less than 10 cm (about 4") away from the wall or back of an audio rack.
- Within reach of children.







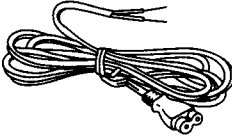
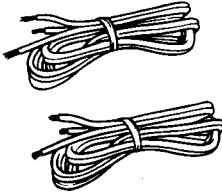

■ When carrying or storing the unit, handle it with care so it is not subjected to any strong bumps.

- Always remove the disc before storing the unit for any period of time.

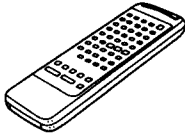
■ To avoid problems due to vibration.

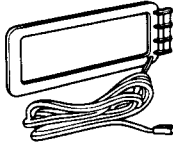
- Do not place a book or similar object under this unit.

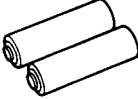
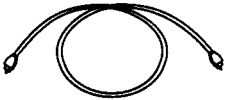
# Supplied Accessories

<p>● AC power supply cord 1 pc.</p> 	<p>● Speaker cords 2 pcs.</p> 	<p>● FM indoor antenna 1 pc.</p> 	<p>● Remote control transmitter &lt;RAK-SC514W&gt; 1 pc.</p> 
<p>● Flat cable 1 pc.</p> 	<p>● LW/MW loop antenna 1 pc.</p> 	<p>● Antenna holder 1 pc.</p> 	<p>● Remote control batteries &lt;UM-4, "AAA", R03&gt; 2 pcs.</p> 
<p>● Optical cable 1 pc.</p> 	<p>● Attachment plug 1 pc. (For United Kingdom only)</p> 	<p>● Mounting screws 2 pcs.</p> 	

**Note:** The configuration of AC power supply cord and FM indoor antenna differ according to area.

# Concerning the Remote Control

## Battery installation

### 1 Open the cover.

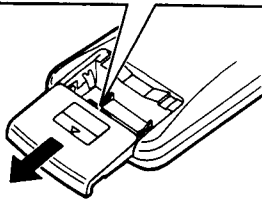

### 1 Open the cover.

Press gently and move the cover in the direction of the arrow.

### 2 Insert the batteries.

Use two UM-4 "AAA", IEC R03 (1.5 V) or equivalent batteries.

### 2 Insert the batteries.

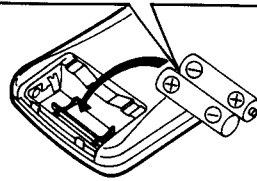

### 3 Close the cover.

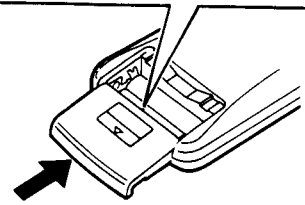

Be sure that the batteries are inserted so that their positive (+) and negative (-) polarities match the polarities indicated in the compartment. Batteries installed incorrectly may leak and cause damage.

Refer to "Use of batteries" for additional information.

### 3 Close the cover.

## Use of batteries

Do not mix old and new batteries, or batteries of different types (carbon and alkaline, etc.).

The battery life is about one year.

Although the battery life varies depending on how often the device is used, the batteries should be replaced about once every year on the average.

The batteries should be replaced if commands from the remote control transmitter do not operate the unit even when the transmitter is held close to the front panel.

Never subject batteries to excessive heat or flame; do not attempt to disassemble them; and be sure they are not short-circuited.

If the remote control is not to be used for a long period of time, remove the batteries and store them in a cool, dark place.

If a battery leaks, remove all batteries. Thoroughly clean the battery compartment before inserting new batteries.

If the electrolyte comes into contact with skin or clothes, flush with water immediately.

Keep batteries out of reach of children.

Do not use rechargeable (nickel-cadmium) type batteries.

Do not attempt to recharge alkaline or carbon batteries.

Always remove old, weak or worn-out batteries promptly.

Do not dispose of used batteries in household rubbish.

## Operation notes

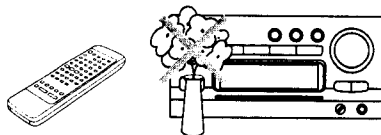

Aim the remote control's transmission window toward the unit's sensor. Avoid any obstacles.

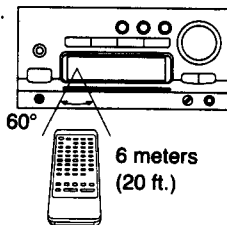

Use the remote control within a 60 degree angle and within 6 meters (20 ft.) from the unit.

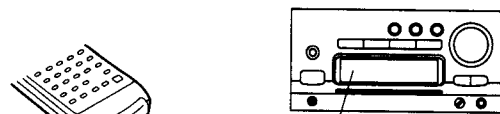

Avoid dust

Avoid dust

Be sure the transmission window and the unit's sensor are free from dust. Excessive dust might prevent reception.

The operation may not be correct if direct sunlight or other strong light source strikes the remote control signal sensor part of this unit. If there is a problem, place the unit away from the light source.

If this unit is installed in a rack with glass doors, the glass door's thickness or color might make it necessary to use the remote control a shorter distance from the unit.

# How to Install the System

Install the various components as shown in the figure.

Do not place any objects on top of this unit. It may interfere the open/close function of the CD tray.

## Installing the components vertically

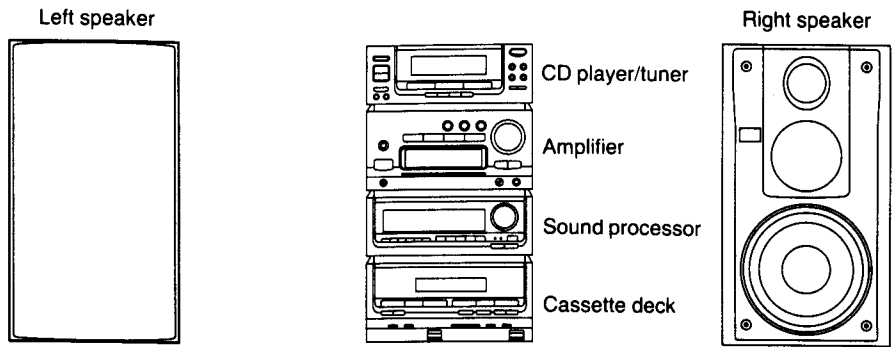

## Installing the components horizontally

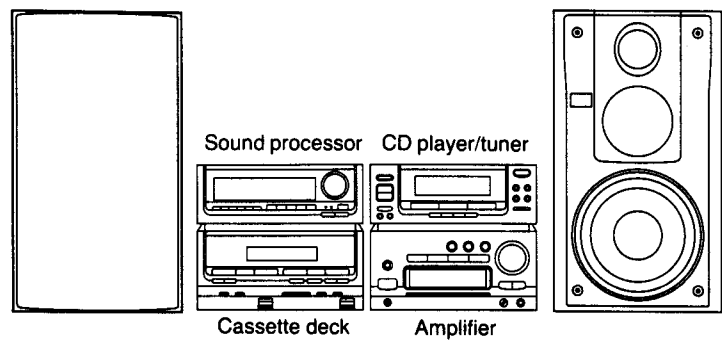

## System layout

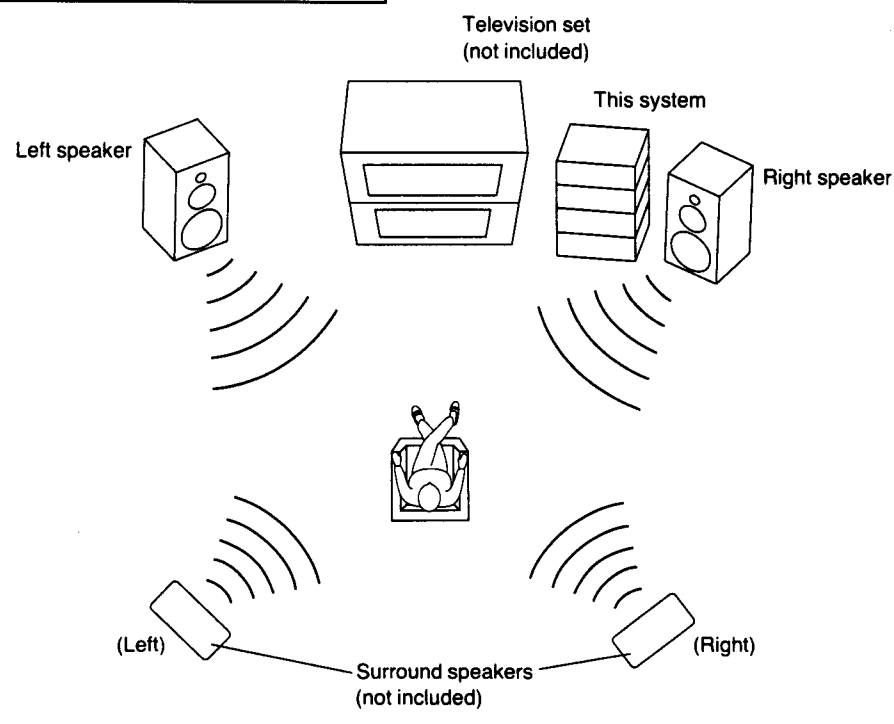

# Connections

## Flat cable

### Connecting

Hold the connector with the recessed part up and press in at the center until you hear a click.

The white line should be on the right side.  
In case of the amplifier, the white line should be on the below side.

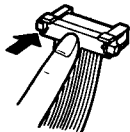

After connection, fold and press the cable as flat to the back of the unit as possible.

### Disconnecting

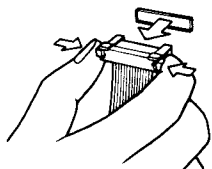

## ■ Installing the components vertically

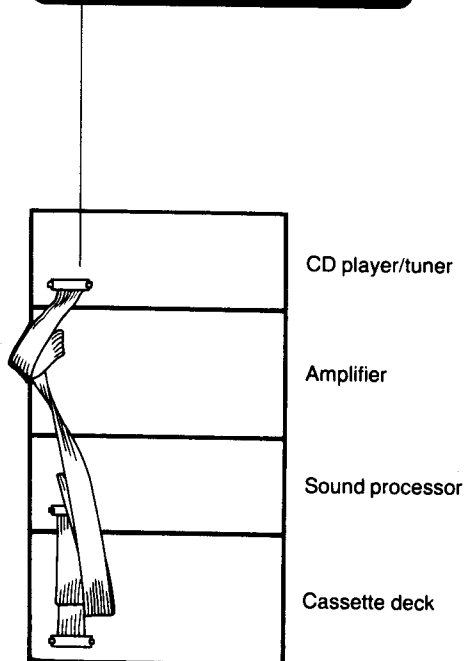

## ■ Installing the components horizontally

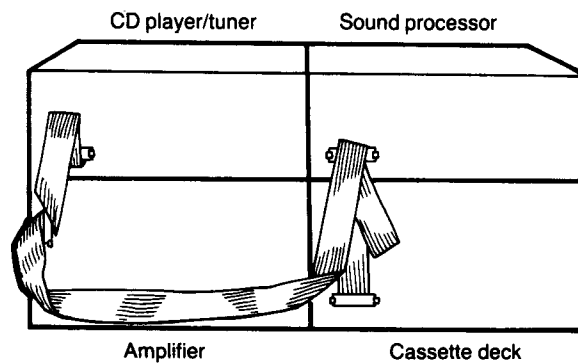

# Connections (continued)

## Speaker cables

Match the two wires from the left and right speaker cables with the same colored levers of the speaker terminals, then insert the wires into the respective terminals.

First connect the cables to the speakers, then to the amplifier.

- 1 Twist the wire.

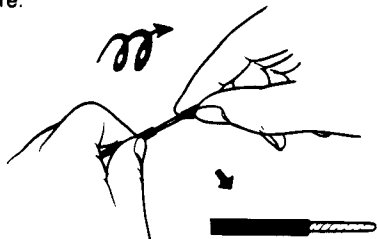

- 2 ⊕: Push up on the lever, insert the bare ends of the wires, and push down the lever. (Refer to the right.)  
 ⊖: Push down on the lever, insert the bare ends of the wires, and push up the lever. (Refer to the right.)

**Note:**

- Make sure the bare ends of the wires are not unraveled. (If they are, twist them tight again.)

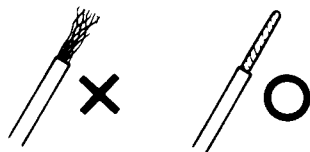

- Take care not to short the wires. (The main unit could be damaged if they are shorted.)

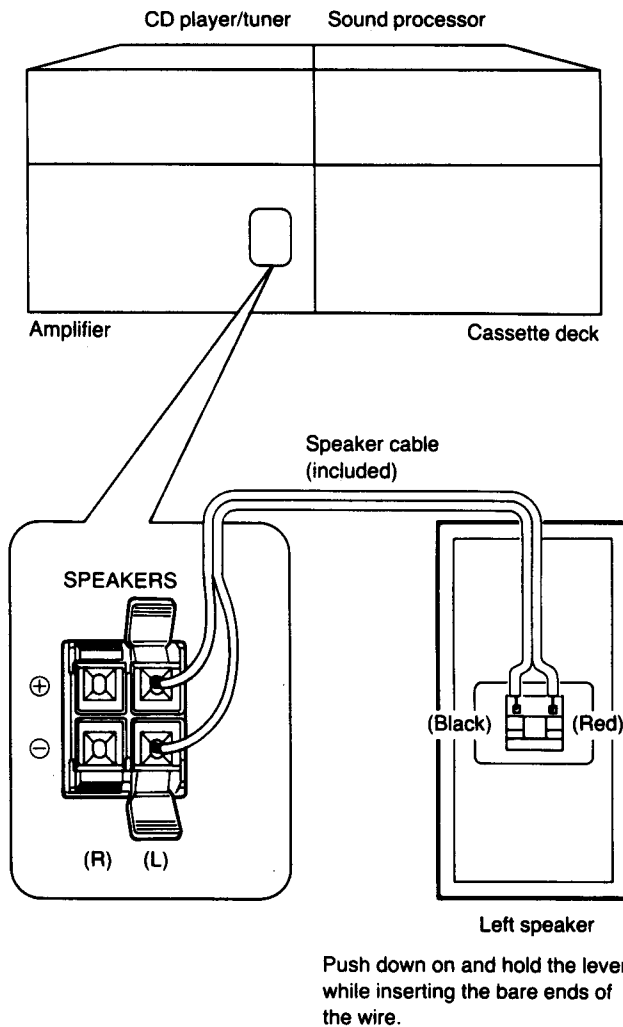
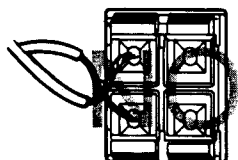



## Optical cable

Connect the optical cable to the CD player/tuner and the sound processor.

- ① Remove a dust-protection cap in the terminal.

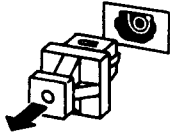

- ② Connect an optical cable.

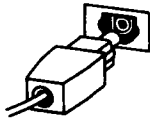

Please keep the dust-protection cap.

### CAUTION

When using the optical cable, please keep the following points in mind:

1. The maximum length of optical cable to be used with this unit is 1 m (approx. 3.3 ft.).
2. Always make sure the plug is fully inserted. If the plug is not inserted all the way, an imperfect connection will result.
3. The optical cable must never be bent or coiled tightly. Doing so will permanently damage the optical fiber in the cable and, therefore, prevent proper data transmission. If the cable must be coiled (for storage, etc.), the diameter of the loop should be at least 15 cm (approx. 6 inches).
4. Handle the optical cable's plug very carefully. Keep the plug free from dust or damage. Dust can be removed by wiping the plug with a soft cloth. Do not use any cleaners or solvents to clean the plug.

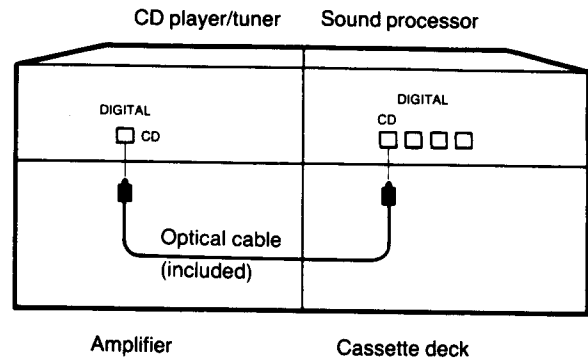

# Connections (continued)

## FM antenna

### ■ FM indoor antenna (included)

Install this antenna on a wall at a height and in a direction which result in the best reception.

#### For best reception sound quality:

An FM outdoor antenna is recommended.

#### Notes:

- The tip of the internal antenna wire should not come into contact with any metal objects.
- Disconnect the antenna if an FM outdoor antenna is installed.

### FM indoor antenna

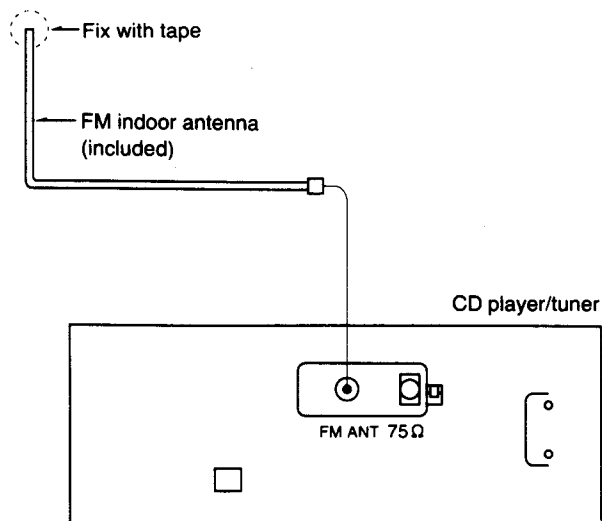

### ■ FM outdoor antenna (not included)

If the FM indoor antenna does not provide satisfactory reception, an outdoor antenna should be used.

The outdoor antenna may be required in a mountainous region, or if this unit is located inside a reinforced-concrete building, etc.

### FM outdoor antenna

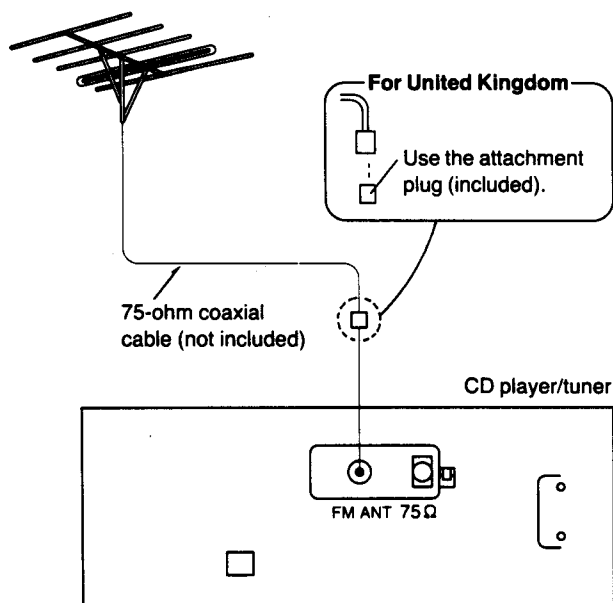

### For areas except United Kingdom

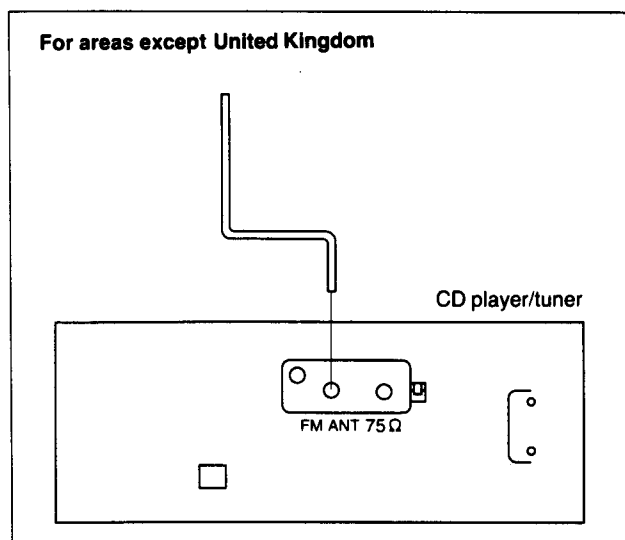

### For areas except United Kingdom (FM outdoor antenna)

1. Remove a piece of the outer vinyl sheath from the end.

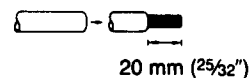

2. Bundle the shield braid, and remove a piece of the inner vinyl sheath covering the core wire.

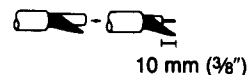

3. Connect the core wire and the shield braid.

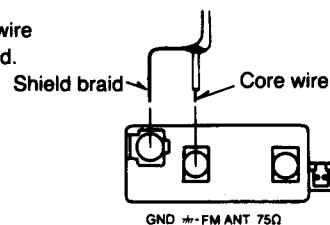

## LW/MW antenna

The indication AM used here includes both MW and LW.

### ■ LW/MW loop antenna (included)

Mount the antenna on a wall or at the CD player/tuner at a height and the direction which results in the best reception.

#### Notes:

- If this antenna is not connected, LW/MW broadcasts can't be received.
- Be sure to connect the LW/MW loop antenna even when an outdoor antenna is used.

#### • How to install the LW/MW loop antenna

To minimize noise pick up, keep the loop antenna away from the speaker cable, power cord and metal surfaces.

The loop antenna can also be mounted on an audio rack.

LW/MW loop antenna (included)

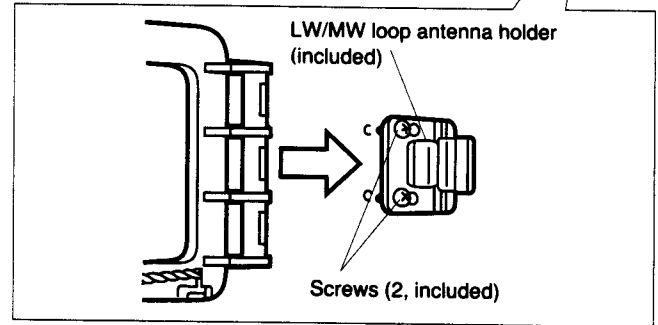
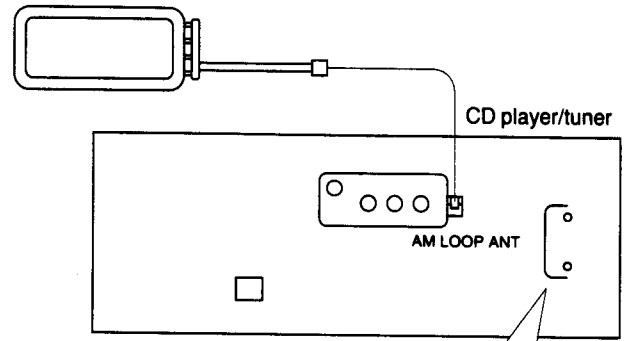

### ■ LW/MW outdoor antenna (not included)

An outdoor antenna may be required in a mountainous region, or if this system is located inside a reinforced-concrete building, etc.

Run 5 to 12 m of vinyl-covered wire horizontally along a window or other convenient location.

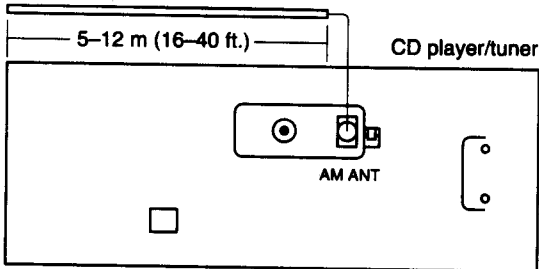

### For areas except United Kingdom

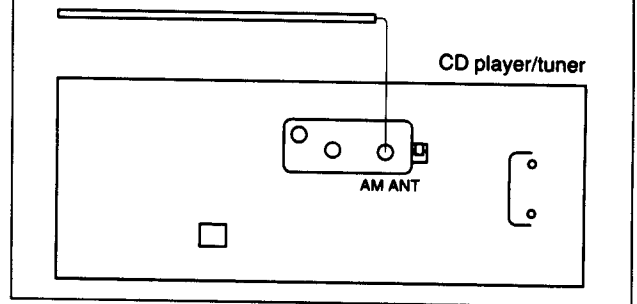

## AC power supply cord

Connect the AC power supply cord after all other cables and cords have been connected.

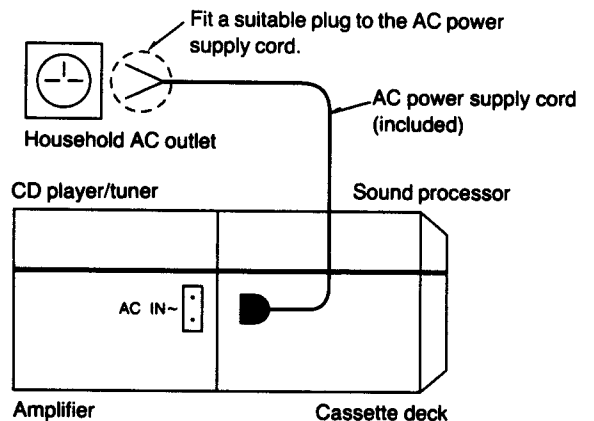

# Connections (continued)

## External unit connection

### ■ Video deck

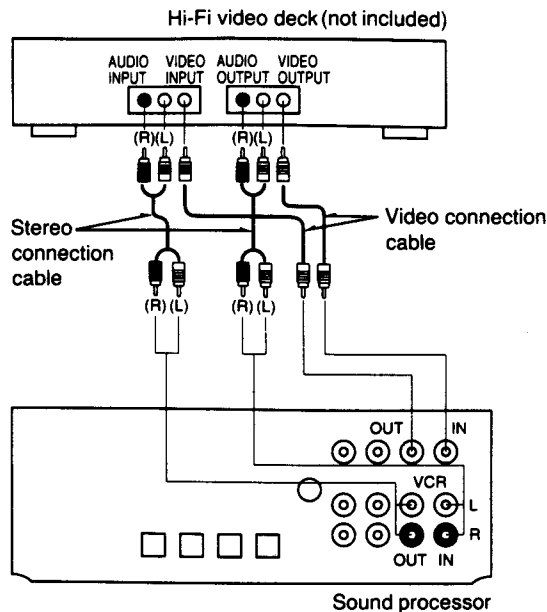

### ■ Video disc player

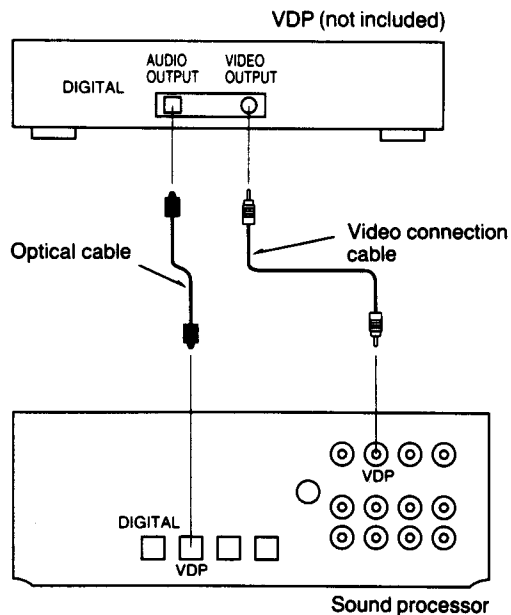

● To use an analogue disc player or video disc player without optical output, connect its stereo connection cable to the VCR IN terminal of the sound processor.

To play the above external unit, press the input select button marked "VCR".

● To use the analogue video disc, connect the video disc player to the VCR IN terminal of the sound processor.

### ■ DAT (digital audio tape deck)

(with optical cables)

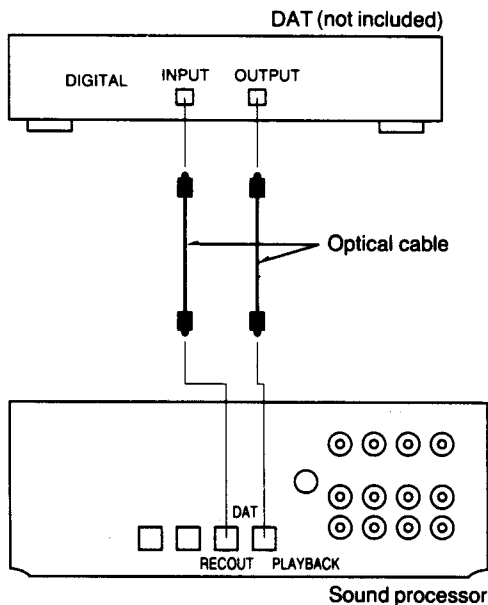

### ■ DAT (only recording out)

(with stereo connection cables)

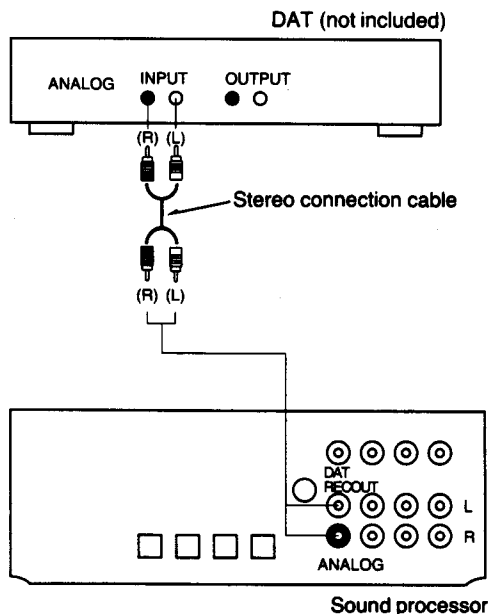

You can record the original sound that you have created with this system to DAT tape.

## External unit connection (continued)

### ■ Analog player

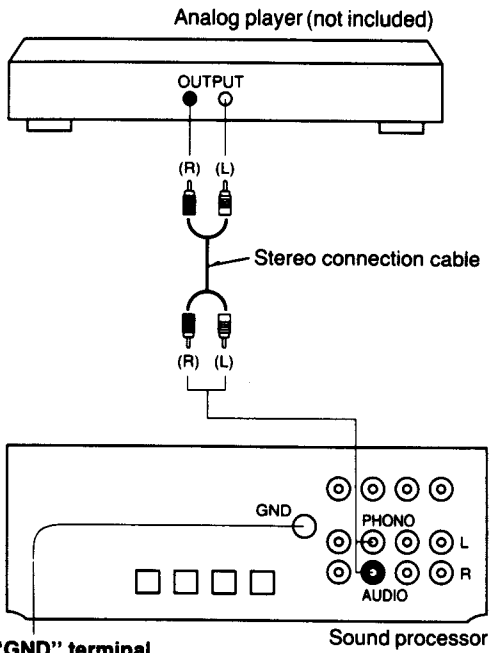

#### ● "GND" terminal

This terminal is for use with turntables which have a ground wire.

### ■ Television

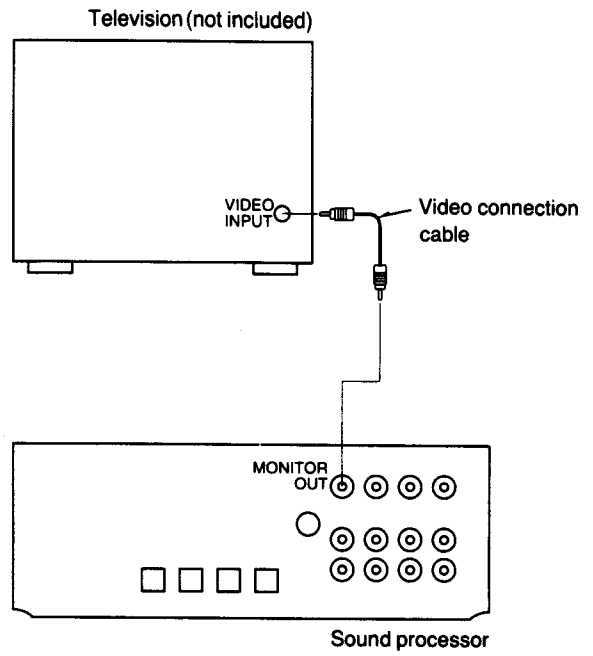

### ■ Surround speakers

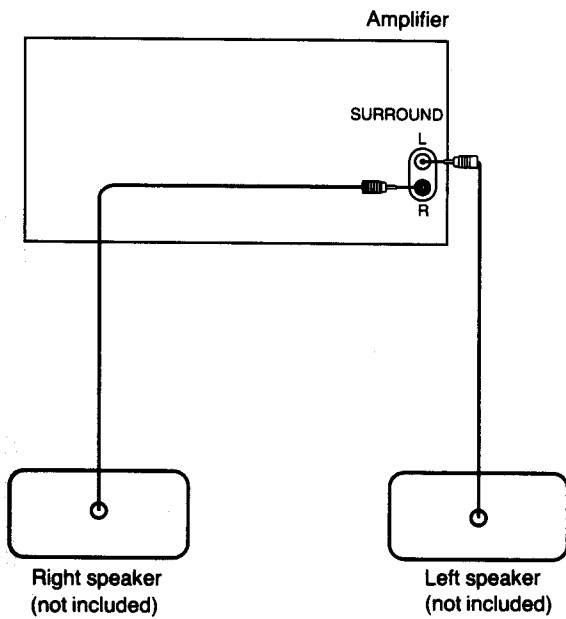

Be sure to connect both speaker systems.  
If only one side is connected, no sound will be heard.

# Front Panel Controls and Functions

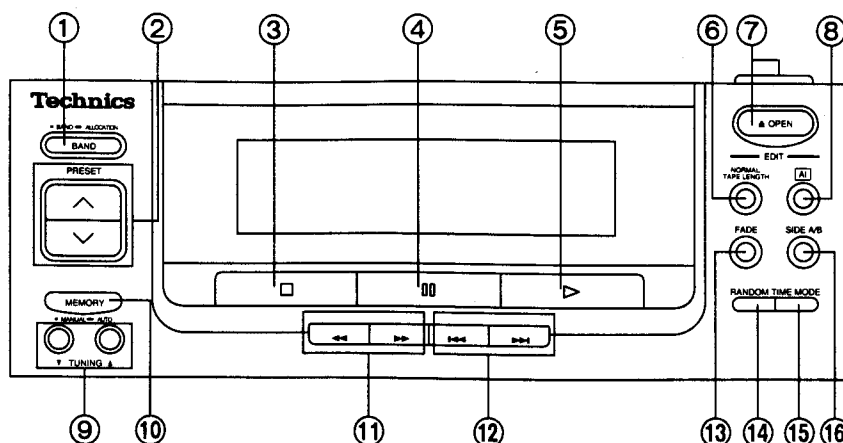

## Compact disc player/tuner section

- ① **Band select button (BAND, -BAND - ALLOCATION)**  
This button is used to select the desired radio band. When press and hold this button, the MW frequency step will change.
- ② **Preset tuning buttons (PRESET)**  
These buttons are used to select channel number for a broadcasting station which has been stored in the tuner's memory.
- ③ **Stop button (□)**  
This button is used to stop the disc play.
- ④ **Pause button (⏸)**  
This button is used to stop the disc play temporarily.
- ⑤ **Play button (▶)**  
This button is used to start playing the disc.
- ⑥ **Normal/tape length edit button (NORMAL/TAPE LENGTH)**  
This button is used to choose one of the edit modes or to specify the tape length to be used.
- ⑦ **Disc tray open/close button (▲ OPEN/CLOSE)**  
These buttons are used to open/close the disc tray.
- ⑧ **AI edit button (AI)**  
This button is used to make an edit recording in one touch action.
- ⑨ **Tuning buttons (▼ TUNING ▲)**  
These buttons are used to tune a desired broadcast station.
- ⑩ **Preset memory button (MEMORY, -MANUAL - AUTO)**  
This button is used to put a broadcast station into the memory.
- ⑪ **Search buttons (◀◀, ▶▶)**  
These buttons are used to move within the program of a compact disc.
- ⑫ **Skip buttons (◀◀, ▶▶)**  
These buttons are used to move (forward and backward) to the beginning of the present or next track, respectively.
- ⑬ **Fade-in edit button (FADE)**  
This button is used to make a fade-in edit recording.
- ⑭ **Random button (RANDOM)**  
This button is used to play all the tracks in random order on the disc.
- ⑮ **Time mode select button (TIME MODE)**  
This button is used to change the time mode. The four patterns of display information will be alternately displayed.
- ⑯ **Tape-side select button (SIDE A/B)**  
This button is used to check the number of tracks and amount of tape left over for side A or B.

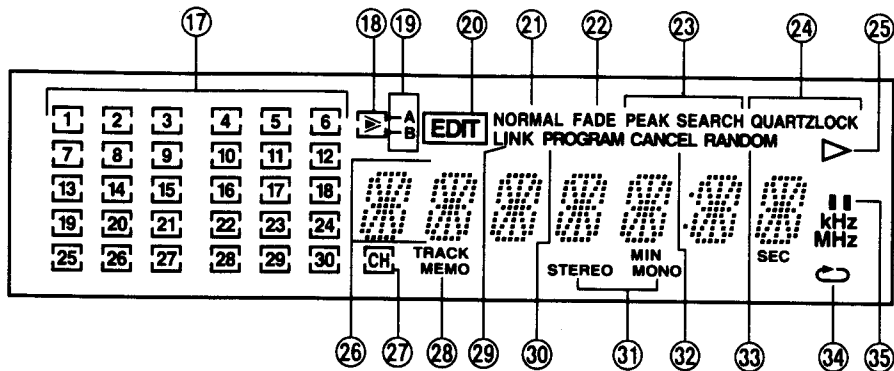

## Display section

- 17 Matrix display ( 1 ~ 30 )**  
This display shows track numbers, preset channels and enlarged track number.
- 18 Over indicator ( ▷ )**  
This indicator illuminates if the total number of tracks on a disc is 31 or more.
- 19 Tape side indicator ( -A, -B )**  
This indicator shows the tape side (A or B) to be recorded on when the edit recording of compact disc is performed.
- 20 Compact disc edit recording indicator ( EDIT )**  
This indicator illuminates when edit recording from a compact disc is performed.
- 21 Normal edit indicator ( NORMAL )**  
This indicator illuminates when the unit is in normal edit mode.
- 22 Fade edit indicator ( FADE )**  
This indicator illuminates when the unit is in fade edit mode.
- 23 Peak search indicator ( PEAK SEARCH )**  
This indicator illuminates when compact disc player is automatically scanning the peak level on a disc. When peak search ends, "PEAK" flashes to indicate the peak level.
- 24 Quartz lock indicator ( QUARTZ LOCK )**  
This indicator illuminates when the unit is precisely tuned to a broadcast station.
- 25 Play indicator ( ▷ )**  
This indicator illuminates when the play mode is activated.
- 26 Multi display**  
This display shows the track number, elapsed play time of the current track, compact disc edit recording mode and received frequencies, etc.
- 27 Channel indicator ( CH )**  
This indicator illuminates when the unit is in the preset tuning.
- 28 Memory indicator ( MEMO )**  
This indicator illuminates when the preset memory button is pressed.
- 29 Link indicator ( LINK )**  
This indicator illuminates when the unit is in a condition where disc link is possible.
- 30 Program indicator ( PROGRAM )**  
This indicator illuminates during program play or the unit is in the edit mode to specify the tape length.
- 31 FM stereo indicator ( STEREO, MONO )**  
This indicator automatically illuminates when an FM stereo broadcast is being received. If the FM mode button is used to select monaural mode, "MONO" indicator will illuminate.
- 32 Cancel indicator ( CANCEL )**  
This indicator illuminates when the programmed track can be cancelled.
- 33 Random indicator ( RANDOM )**  
This indicator illuminates during random play.
- 34 Repeat play indicator ( ↻ )**  
This indicator illuminates during repeat play.
- 35 Pause indicator ( II )**  
This indicator illuminates when the pause mode is activated.

# Front Panel Controls and Functions

(continued)

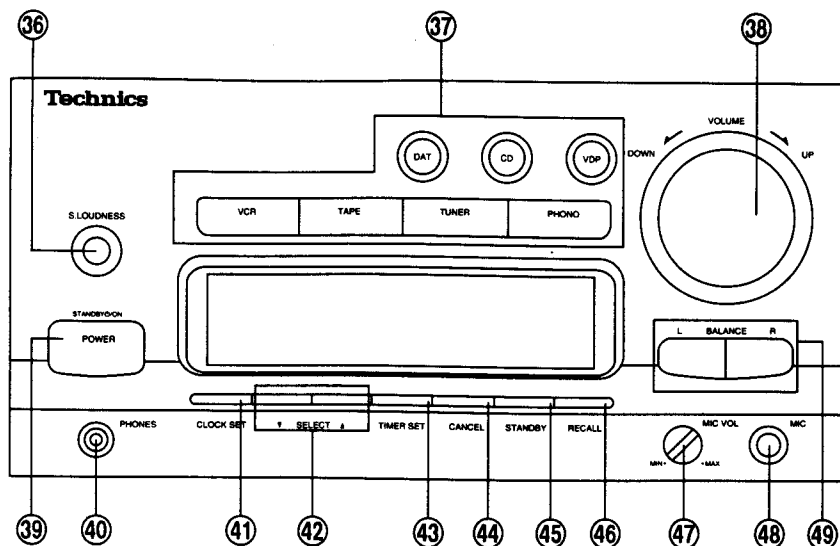

## Amplifier section

- 36 Loudness button (S. LOUDNESS)**  
This button is used to boost the dynamic low frequency ranges in a low volume level.
- 37 Input select buttons (DAT, CD, VDP, VCR, TAPE, TUNER, PHONO)**  
These buttons are used to select the sound source to be heard.
- 38 Volume level control (VOLUME)**  
This control is used to adjust the volume level. Note that "-- dB" is the lowest volume setting and "0 dB" is the highest level setting.
- 39 Power "STANDBY  $\odot$ /ON" switch (POWER STANDBY  $\odot$ /ON)**  
This switch switches ON and OFF the secondary circuit power only. The unit is in the "standby" condition when this switch is set to the STANDBY  $\odot$  position. Regardless of the switch setting, the primary circuit is always "live" as long as the power cord is connected to an electrical outlet.
- 40 Headphones jack (PHONES)**
- 41 Clock set button (CLOCK SET)**  
This button is used to set the present time.
- 42 Timer select buttons ( $\nabla$  SELECT  $\blacktriangle$ )**  
These buttons are used when setting the time, making the timer setting, selecting the type of timer operation, etc.
- 43 Timer set button (TIMER SET)**  
This button is used to enable the timer set mode and the current selection, selected by the timer select buttons.
- 44 Timer cancel button (CANCEL)**  
This button is used to cancel the timer setting.
- 45 Timer standby button (STANDBY)**  
This button is used to cancel the timer setting temporarily.
- 46 Timer setting confirmation button (RECALL)**  
This button is used to confirm the timer settings.
- 47 Microphone volume control (MIC VOL.)**  
This control is used to adjust the microphone volume level.
- 48 Microphone jack (MIC)**
- 49 Balance adjustment buttons (BALANCE)**  
These buttons are used to adjust the volume balance.



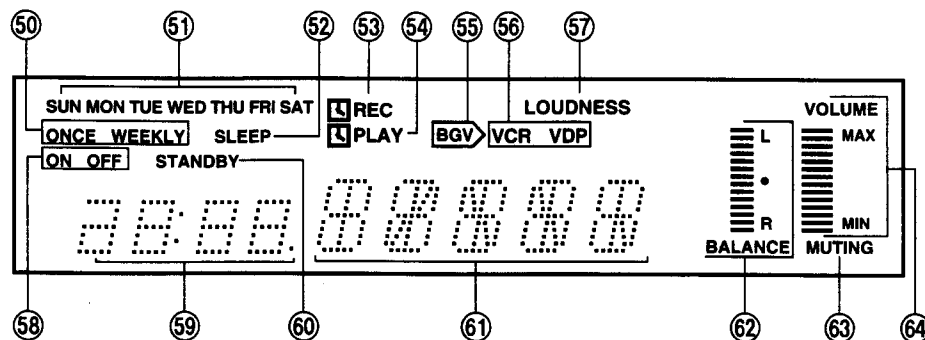

## Display section

- 50 Timer mode indicator (ONCE, WEEKLY)**  
These indicators show the timer operation mode.
- 51 Day indicators (SUN~SAT)**  
These indicators show the day of a week or the day the timer has been set for.
- 52 Sleep indicator (SLEEP)**  
This indicator illuminates when the sleep timer is activated.
- 53 Timer recording indicator (REC)**  
This indicator illuminates when timer recording mode has been activated.
- 54 Timer play indicator (PLAY)**  
This indicator illuminates when timer play mode has been activated.
- 55 BGV (background visual) indicator (BGV)**  
This indicator illuminates when listening to audio sound source.
- 56 Visual source indicator (VCR, VDP)**  
These indicators shows the input mode of visual source.
- 57 Loudness indicator (LOUDNESS)**  
This indicator illuminates when the loudness button is pressed.
- 58 Timer on/off indicator (ON, OFF)**  
These indicators illuminate to show whether the ON time and OFF time have been set.
- 59 Time display**  
This display shows the current time, or the time the timer has been set for.
- 60 Timer standby indicator (STANDBY)**  
This indicator illuminates to show the standby condition of timer play/recording.
- 61 Multi display**  
This display shows the selected source, volume level, etc.
- 62 Balance display (BALANCE)**  
This display shows the left-right balance.
- 63 Muting Indicator (MUTING)**  
This indicator illuminates when the muting mode is activated.
- 64 Volume level display**  
This display shows the volume level.

# Front Panel Controls and Functions

(continued)

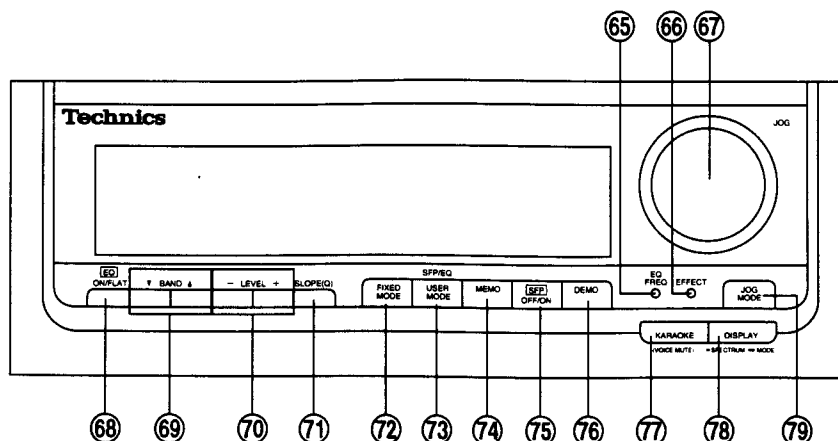

## Sound processor section

- 65 Equalizer frequency indicator (EQ FREQ)**
- 66 Effect indicator (EFFECT)**
- 67 Sound effect level control (JOG)**  
This control is used for adjusting the level of surround sound effect, equalization level and specific frequency shift.
- 68 Equalizer ON/FLAT button (EQ, ON/FLAT)**  
This button is used to switch the equalizer on or flat.
- 69 Equalizer frequency select buttons (▼ BAND ▲)**  
These buttons are used to select one of the desired equalization frequency bands (LOW, HIGH1, HIGH2).
- 70 Equalizer level-control buttons (- LEVEL +)**  
These buttons are used to adjust of equalization level.
- 71 Slope (Q) select button [SLOPE (Q)]**
- 72 Fixed mode select button (FIXED MODE)**  
This button is used to select the fixed mode of equalization curve or ambience enhancement.
- 73 User mode select button (USER MODE)**  
This button is used to select the user mode of equalization curve or ambience enhancement.
- 74 Memory button (MEMO)**  
This button is used to store an original equalization curve or ambience enhancement.
- 75 SFP OFF/ON button (SFP, OFF/ON)**  
This button is used to activate ambience enhancement.
- 76 Demonstration button (DEMO)**  
This button is used to change sound effects sequentially.
- 77 Voice mute button (KARAOKE)**  
This button is used to change "karaoke" (using microphone with an accompaniment).
- 78 Display mode select button (DISPLAY, -SPECTRUM -MODE)**  
This button is used to select one of three spectrum displays. If you press and hold this button, the equalization curve is displayed together with the spectrum display.
- 79 Jog mode button (JOG MODE)**  
This button is used to select the mode of adjusting with sound effect level control.

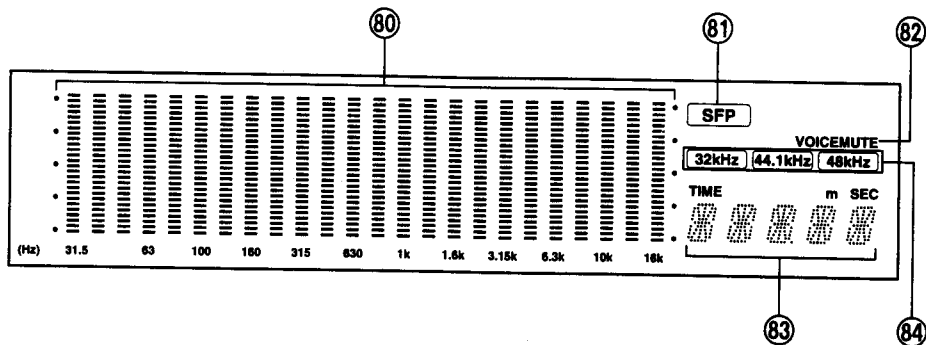

## Display section

- 80 Multi level display**  
This display shows the equalization/spectrum analysis level.
- 81 SFP Indicator (SFP)**  
This indicator illuminate to activate ambience enhancement.
- 82 Voice mute indicator (VOICE MUTE)**  
This indicator illuminates to activate "karaoke" function.
- 83 Sound effect display**  
This display shows the mode of equalization curve or ambience enhancement, or delay time, etc.
- 84 Sampling frequency indicators**  
These indicators illuminate whenever a digital signal with one of the sampling frequencies listed below is detected at "DIGITAL" terminal on the rear panel of the sound processor.

  - 32 kHz:** For digital signals with the 32-kHz mode sampling frequency.  
(For example, DAT 32-kHz mode)
  - 44.1 kHz:** CD, DAT and others.
  - 48 kHz:** For digital signal with the 48-kHz mode sampling frequency.  
(For example, DAT 48-kHz mode)

# Front Panel Controls and Functions

(continued)

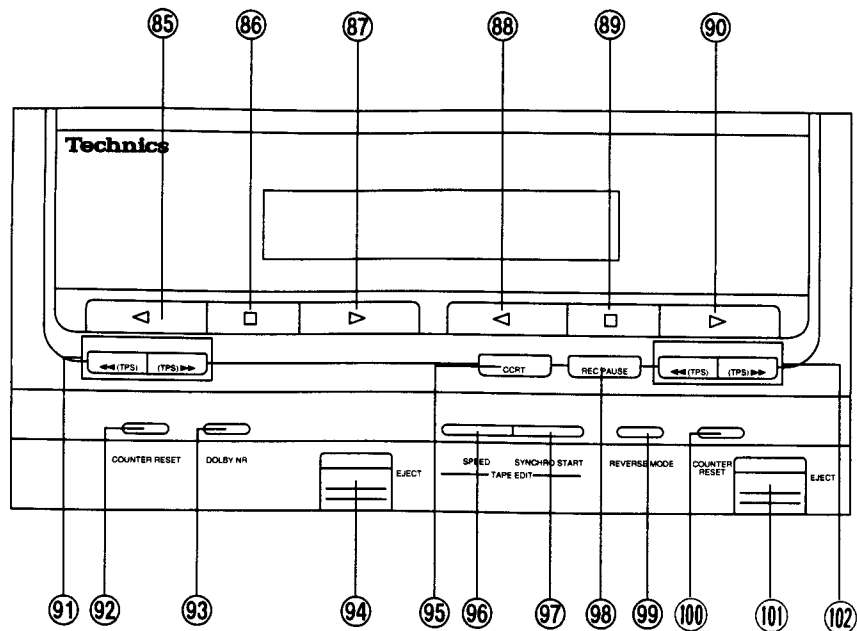

## Cassette deck section

- 85 Deck 1 reverse side playback button (<)**  
This button is used to start the playback in the reverse direction.
- 86 Deck 1 stop button (□)**  
This button is used to stop a tape.
- 87 Deck 1 forward side playback button (>)**  
This button is used to start the playback in the forward direction.
- 88 Deck 2 reverse side playback button (<)**  
This button is used to start the playback or recording in the reverse direction.
- 89 Deck 2 stop button (□)**
- 90 Deck 2 forward side playback button (>)**  
This button is used to start the playback or recording in the forward direction.
- 91 Deck 1 Fast-forward/rewind/tape program sensor buttons [◀◀ (TPS), (TPS) ▶▶]**  
These buttons are used to advance or rewind a tape, or to quickly search for beginning of a program which the tape is being played.
- 92 Deck 1 counter reset button (COUNTER RESET)**  
This button is used to reset the tape counter indicator to "0000".
- 93 Dolby noise reduction button (DOLBY NR)**  
This button is used to reduce the hissing noise heard from a tape. This unit is provided with both the Dolby B-type and Dolby C-type noise reduction.
- 94 Deck 1 cassette eject button (EJECT)**  
This button is used to open the cassette holder.
- 95 CCRT (computer control record tuning) button (CCRT)**  
This button is used to adjust the recording level, equalization and bias automatically.
- 96 Edit speed select button (SPEED)**  
This button is used to select the recording speed when making a tape-to-tape recording.
- 97 Synchro start button (SYNCHRO START)**  
This button is used to start a tape-to-tape recording, simultaneously starting deck 1 (the playback deck) and the deck 2 (the recording deck).
- 98 Record/record standby button (REC PAUSE)**  
This button is used to put deck 2 into the record standby mode.
- 99 Reverse mode select button (REVERSE MODE)**  
This button is used to select reverse mode for playback and recording.
- 100 Deck 2 counter reset button (COUNTER RESET)**
- 101 Deck 2 cassette eject button (EJECT)**
- 102 Deck 2 Fast-forward/rewind/tape program sensor buttons [◀◀ (TPS), (TPS) ▶▶]**

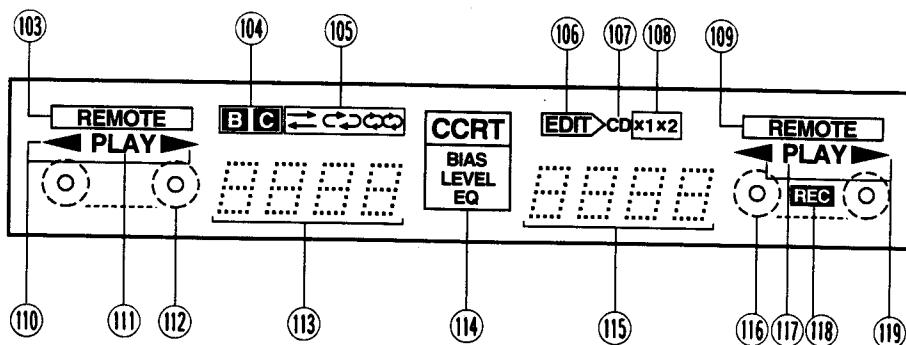

## Display section

- 103 Deck 1 remote indicator (REMOTE)**  
This indicator illuminates to show that deck 1 can be operated with remote control.
- 104 Dolby noise reduction indicators (B, C)**  
This indicator illuminates to show the type of Dolby noise reduction system.
- 105 Reverse mode indicators (↔, ↺, ↻)**  
These indicators illuminate to show the reverse mode.
- 106 Edit indicator (EDIT)**  
This indicator illuminates when making an edit-recording from a compact disc, or tape-to-tape recording.
- 107 CD edit indicator (CD)**  
This indicator illuminates to show edit-recording of a compact disc is being made.
- 108 Edit speed indicators (x1, x2)**  
These indicators illuminate to show the edit speed of tape-to-tape recording.
- 109 Deck 2 remote indicator (REMOTE)**  
This indicator illuminates to show that deck 2 can be operated with remote control.
- 110 Deck 1 tape travel direction indicators (◀, ▶)**  
These indicators illuminate to show the direction of tape travel.
- 111 Deck 1 playback indicator (PLAY)**  
This indicator illuminates to show that deck 1 is in the playback mode.
- 112 Deck 1 tape indicator**  
This indicator illuminates to show that there is a tape in deck 1.
- 113 Deck 1 tape counter**  
This indicator shows the amount of tape movement in deck 1.
- 114 CCRT indicator**  
This indicator illuminates when CCRT function is activated.
- 115 Deck 2 tape counter**
- 116 Deck 2 tape indicator**  
This indicator illuminates to show that there is a tape in deck 2.
- 117 Deck 2 playback indicator (PLAY)**  
This indicator illuminates to show that deck 2 is in the playback mode or recording mode.
- 118 Recording indicator (REC)**  
This indicator illuminates when in the recording (recording standby) mode.
- 119 Deck 2 tape travel direction indicators (◀, ▶)**

# Front Panel Controls and Functions

(continued)

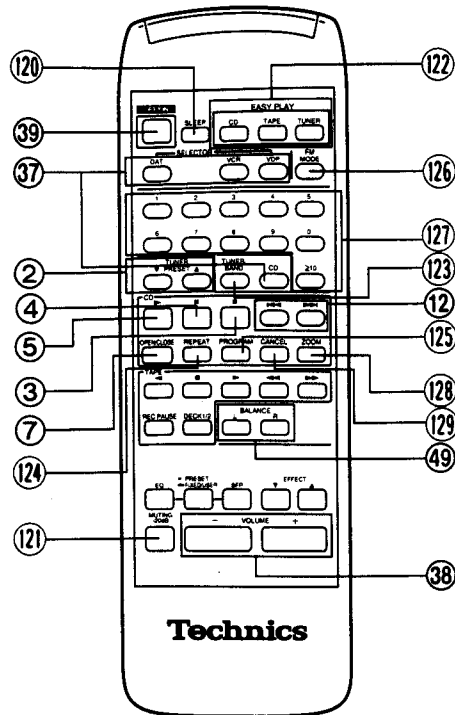

## Remote control section (I)

The descriptions of the buttons which are same as the main unit are omitted.

### ■ Common control operation controls

- ⑫⑩ **Sleep timer button (SLEEP)**  
This button is used when you wish to fall asleep while listening to the music.
- ⑫① **Muting button (MUTING -20 dB)**  
This button is used to temporarily attenuate the volume level.
- ⑫② **Easy play buttons (EASY PLAY)**

### ■ Compact disc player/tuner section

- ⑫③ **Tuner/band select button (TUNER/BAND)**  
This button is used to select tuner mode and select a band.

- ⑫④ **Repeat button (REPEAT)**  
This button is used to activate the repeat mode.
- ⑫⑤ **Program button (PROGRAM)**  
This button is used to perform the program play.
- ⑫⑥ **FM mode button (FM MODE)**  
This button is used to select the FM listening mode (stereo or monaural) during on FM broadcast station.
- ⑫⑦ **Numeric buttons (1~0, ≥10)**  
**When the CD source is selected:**  
These buttons are used to specify a compact disc's track.  
**When the tuner source is selected:**  
These buttons are used to tune to broadcast station which have been preset in the unit's memory.
- ⑫⑧ **Zoom button (ZOOM)**  
This button is used to display enlarged a track number.
- ⑫⑨ **Cancel button (CANCEL)**  
This button is used to cancel tracks selected for program play.

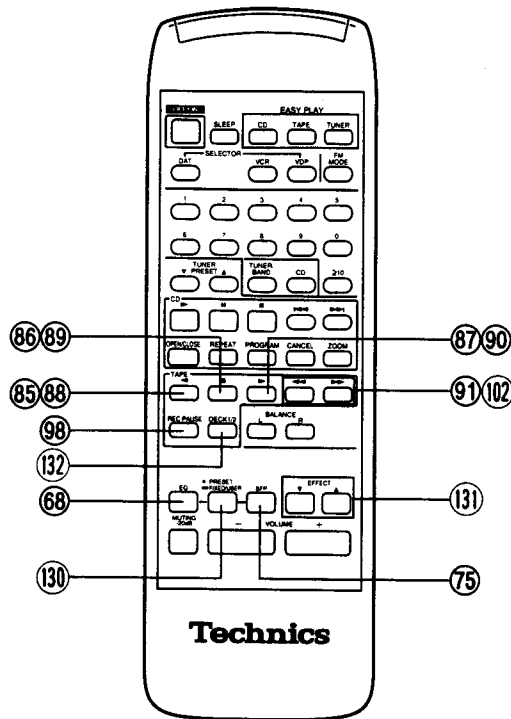

## Remote control section (II)

The descriptions of the buttons which are same as the main unit are omitted.

### ■ Sound processor section

#### (130) Sound effect select button (-PRESET, -FIXED/USER)

This button is used to select the mode of preset equalization curve or surround sound. If you press and hold this button, preset mode and user mode will be switched and vice versa.

#### (131) Effect buttons (▼ EFFECT ▲)

These buttons are used to adjust the equalization level or reverberation sound.

### ■ Cassette deck section

#### (132) Deck 1/2 selector (DECK 1/2)

This button is used to select the deck to be operated with the remote control.

# Basic Operating Procedure

These functions can also be performed from the remote control. Follow the procedure described below.

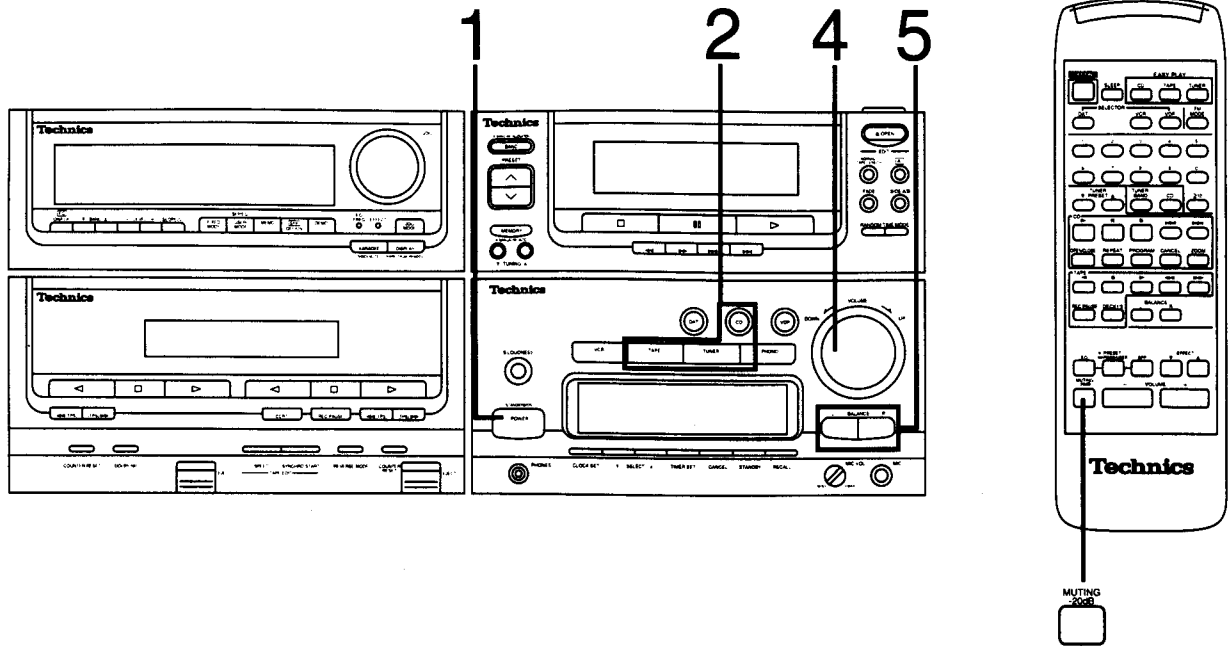

- 1 Press the power "STANDBY  /ON" switch to switch on the power.
- 2 Press the input select button to select the desired sound source.  
The display of the selected mode will appear.  
**TAPE:** Press this button to listen to tapes (See page 34).  
You can skip this step from the remote control.  
**CD:** Press this button to listen to compact discs.  
The compact disc or tape will automatically stop when a different sound mode is selected during its operation (See page 28).  
**TUNER:** Press this button to listen to radio broadcasts (See page 38).
- 3 Start the sound source.
- 4 Adjust the volume level.
- 5 Adjust the left-right volume balance.  
Pressing the balance adjustment buttons simultaneously will restore the balance to the center position.  
 •Perform fine balance adjustment while playing the selected music source. The balance display is only a rough quick.

## After listening is finished

Be sure to reduce the volume level and switch the unit to the standby mode using the power "STANDBY  /ON" switch or the "OFF/ON" switch on the remote control.

### Note:

The sound source and equalizer settings will be retained (as they were at the time when the power is switched to standby mode) by the memory back-up function.

## To temporarily reduce the volume level

Press the muting button on the remote control.



The muting indicator on the amplifier illuminates.

The volume level is attenuated by 20 dB (approx. 1/10).  
The muted state can be cancelled by pressing the muting button once again or reduce the volume level by setting the volume level to the "-- dB" position.



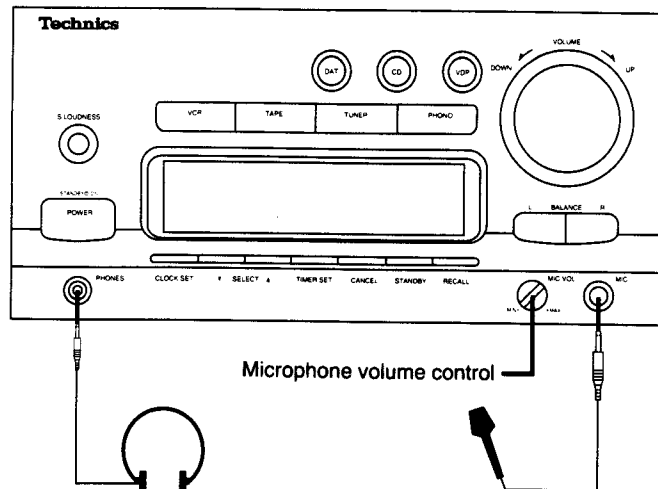

### How to use a microphone

Connect the microphone (not included) to the MIC jack after reducing the volume level.

Microphone volume level is adjusted with the microphone volume control.

It is possible to record a singing voice accompanying the tuner or compact disc. Follow the instructions for "Making a Recording" on page 41 and "Enjoying the Microphone Mixing" on page 67.

- Plug: 1/4 inch mono type

### How to use headphones

Connect the headphones (not included) to the PHONES jack after reducing the volume level.

The speakers are automatically cut off when the headphones are connected.

- Avoid listening for prolonged periods of time to prevent hearing damage.
- Plug: Stereo mini type

# Basic Operating Procedure (continued)

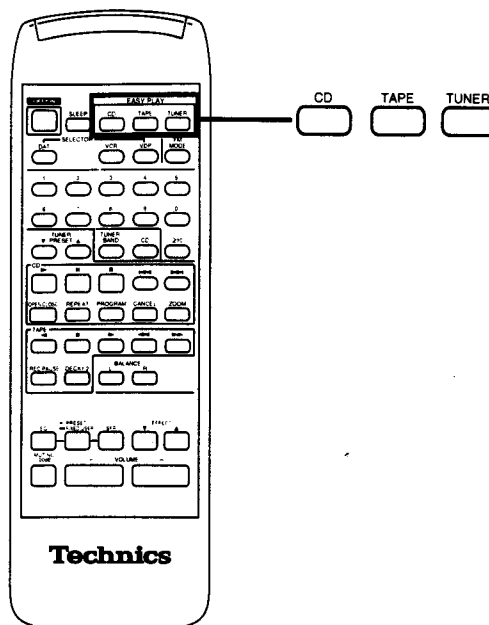

## Easy play

You can start the play by simply pressing the easy play button even when the power is switched to standby mode.

### ■ Listening to compact discs

**Press the easy play button marked "CD".**

The play will start automatically from the first track.

### ■ Listening to tapes

**Press the easy play button marked "TAPE".**

The playback will automatically start under the same conditions (tape direction and reverse mode) last set when the power was switched to standby mode.

In case a tape has been loaded in both decks, deck 1 has priority.

### ■ Listening to radio broadcasts

**Press the easy play button marked "TUNER".**

The station last tuned to when the power was switched to standby mode will be automatically received when power is switched ON.

# Setting the Time

1.3.5.7      2.4.6

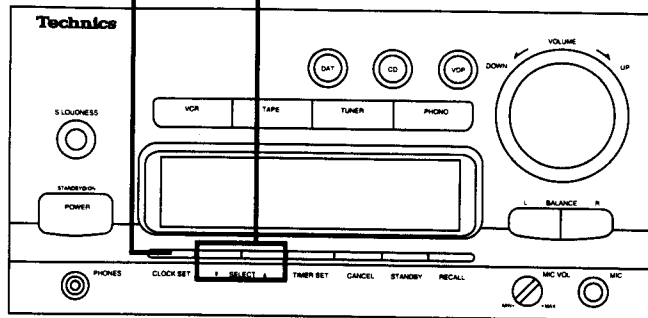

## For example:

To set the time at 16:25 on Wednesday (4:25 pm).

**Have you switched on the power?**

- 1 Press the clock set button.  
The day indicator will start to flash.
- 2 Press one of the timer select buttons to select "WED".
- 3 Press the clock set button.

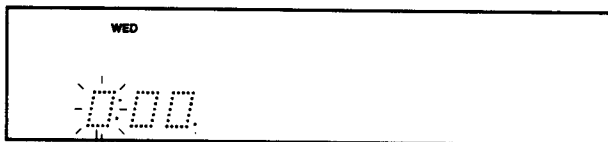

Flashing

- 4 Press one of the timer select buttons to select "16".

- 5 Press the clock set button.

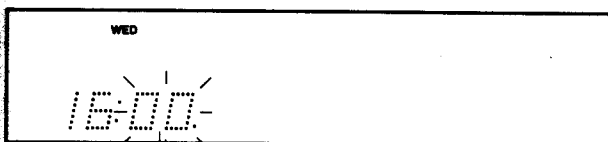

Flashing

- 6 Press one of the timer select buttons to select "25".

Note that the minute "00" display appears following "59", but the hour display is not changed.

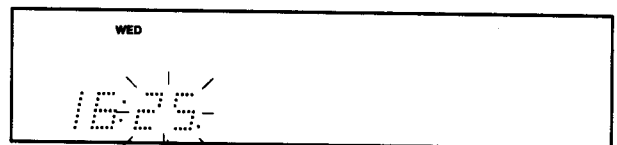

Flashing

- 7 Press the clock set button to finish setting the time.

The dot indicator will start to flash to indicate the clock is working.

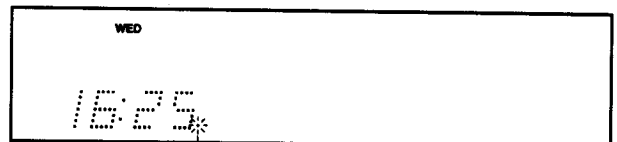

Flashing

## Note:

• "E" appears on the display when the power cord is connected or by electricity failure. Set the time once again.

# Listening to Compact Discs

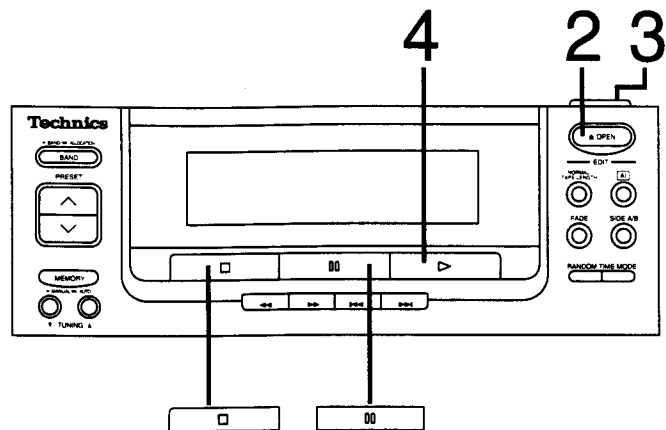

## Sequential play

This function can also be performed from the remote control. Follow the procedure below.

Have you switched on the power?

- 1 Press the input select button marked "CD" on the amplifier.
- 2 Press the disc tray open/close button to open the disc tray and then insert the disc.

Label must face upward

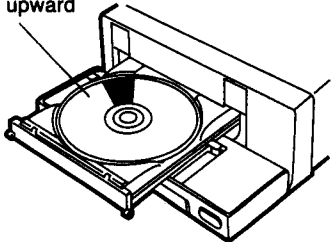

- 3 Press the disc tray open/close button to close the disc tray.

When the disc tray is closed, the disc rotates, and the total number of tracks and total playing time both appear on the display panel.

- Do not stick your finger through the hole in the middle of the disc tray. (It could get caught when the tray closes.)

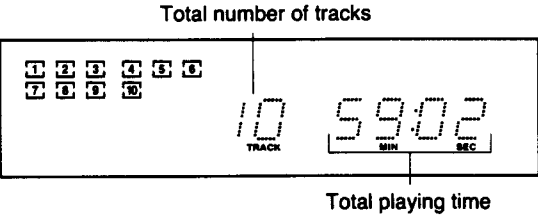

- When there are more than 31 tracks on the disc, the "E" mark will be displayed.

- 4 Press the play button. Disc play begins from the first track on the disc.
  - The frame of the track being played will flash, and go out at the end of that track.

The frame of track number currently played flashes.

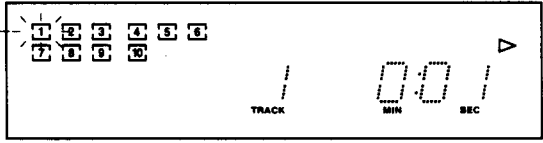

- The disc play stops automatically when the last track on the disc finishes playing. (The display returns to the total number of tracks and total playing time indications.)
- The item 3 can be skipped by pressing the play button on the remote control after inserting a disc, in this case, the tray will close and play will start directly from track 1, but the tracks and total playing time will not be displayed.
- The total playing time displayed on the unit includes the time between tracks, hence there may sometimes be a difference of several seconds between this time and the playing time indicated in the liner notes that comes with the disc.

### To temporarily stop the disc play

This function can also be performed from the remote control. Follow the procedure below.

Press the pause button.



Pause indicator illuminates.

- Press the play button to play again.

### To stop disc play

This function can also be performed from the remote control. Follow the procedure below.

Press the stop button.

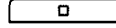

The unit switches to the stop mode and the total number of tracks and total playing time are displayed.

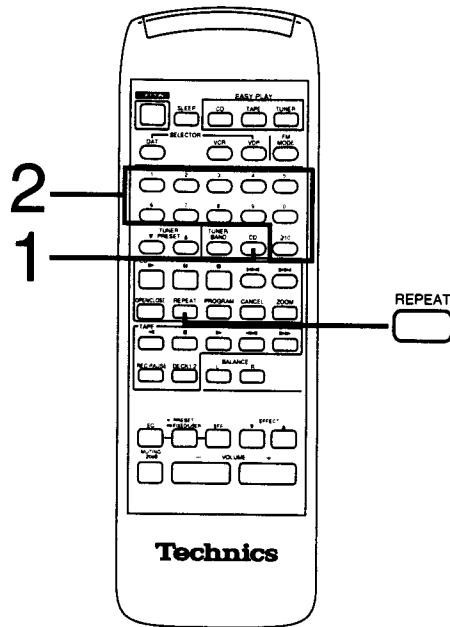

## Direct access play

To start sequential play from a specific track to the last track and then the disc automatically stops.

- 1 Press the input select button marked "CD".
- 2 Press the numeric button corresponding to the desired track number.

### To select a specific track

Tracks 1-9:

Press the appropriate numeric button 1-9 directly.

Tracks 10 and up:

First press the "10" button and then one of the "1" to "9" buttons.

Track no. 13:

Track no. 20:

Track no. 35:

Play will start.

### Note:

Direct access play is not possible in the programmed play mode. (Tracks are added onto the programmed tracks.) Release the program mode function first and then proceed to operate.

## Repeat play

This function repeats the play of all tracks.

Press the repeat button before or during play.

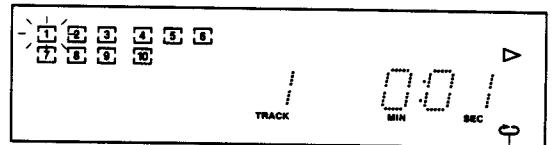

Repeat play indicator will illuminate.

- While program play is taking place, only the programmed tracks will be played repeatedly.
- You can enjoy the same track repeatedly if only one track is programmed.

### ■ To cancel repeat play

Press the repeat button once again and the repeat indicator will go out.

# Listening to Compact Discs (continued)

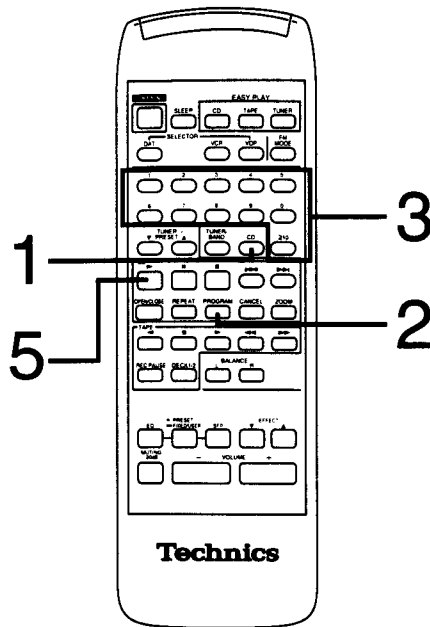

## Program play

The function allows you to program up to 30 tracks on the disc in any order you choose.

- 1 Press the input select button marked "CD".
- 2 Press the program button.  
The program indicator will illuminate.

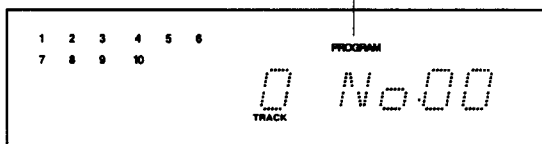

- 3 Press the numeric buttons to select the desired track numbers.

### To select a specific track

Tracks 1-9:

Press the appropriate numeric button 1-9 directly.

Tracks 10 and up:

First press the "≥10" button and then one of the "1" to "9" buttons.

Track no. 13: .

Track no. 20: .

Track no. 35: .

### Notes:

• "F" appears on the track display when more than 31 tracks have been programmed, to indicate that more than 31 tracks cannot be programmed.

- 4 Repeat step 3 until the desired program is completed.

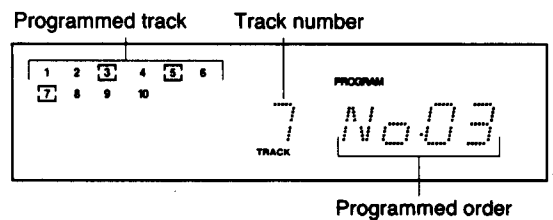

- 5 Press the play button.  
The program play will begin.

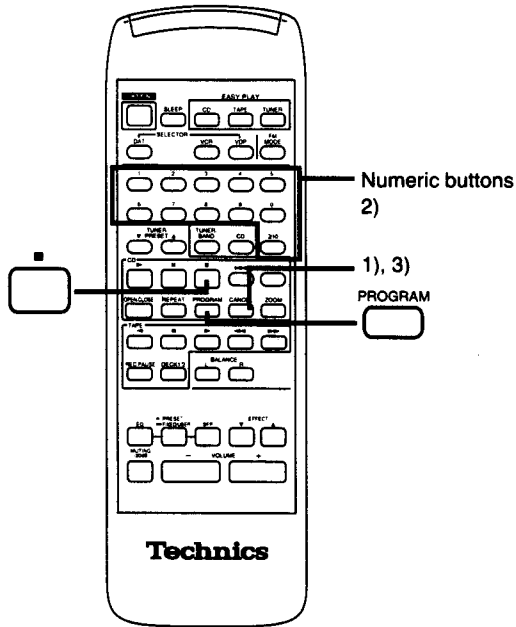

■ **To enter additional program selections**

Press the numeric button corresponding to the track to be added.

■ **To cancel the selected tracks one by one**

- 1) Press the cancel button.  
The cancel indicator will illuminate.
- 2) Press the numeric button of the track to be cancelled.
- 3) Press the cancel button.  
The cancel indicator will go out.

■ **To cancel an entire program**

Press the stop button when a disc is not being played (or twice when a disc is being played).



The entire program will be cancelled.

■ **To resume the sequential play**

Press the program button while the disc is being played.



That changes to sequential play when a disc is being played.

# Listening to Compact Discs (continued)

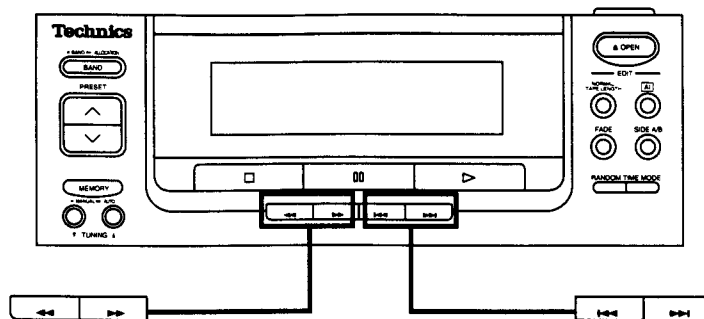

## Search play

Use this function while playing a disc to search rapidly forward or backward for specific sections.

**While watching the track and time displays, press and hold one of the search buttons. Release the button when the desired point has been reached.**

 : Press and hold this button to search forward.

 : Press and hold this button to search backward.

- At first, the pickup will move slowly, then, if the button is kept depressed, will move quickly.
- The volume level will drop to about  $\frac{1}{4}$  of normal.
- During program play and random play, search will take place within the track being played.

## Skip play

This function can also be performed from the remote control. Follow the procedure described below.

Use this function to skip to the beginning of tracks preceding or following the track in play and begins play immediately.

**Press the forward or backward skip button momentarily until the desired track has been located.**

 : Press this button to skip forward.  
The pickup will skip as many tracks as the number of times the button is pressed.

 : Press this button to skip backward.  
Pressing this button once will cause the pickup to move to the beginning of the track being played.

- If these buttons are pressed during program play, the pickup will skip from one track to another in the programmed sequence.

### Pickup:

The pickup is a laser device that reads the information on the disc surface. The pickup moves across the disc as the disc is played, but it is not visible from outside the cabinet.

### Note:

During random play, it is not possible to skip to the previous track.



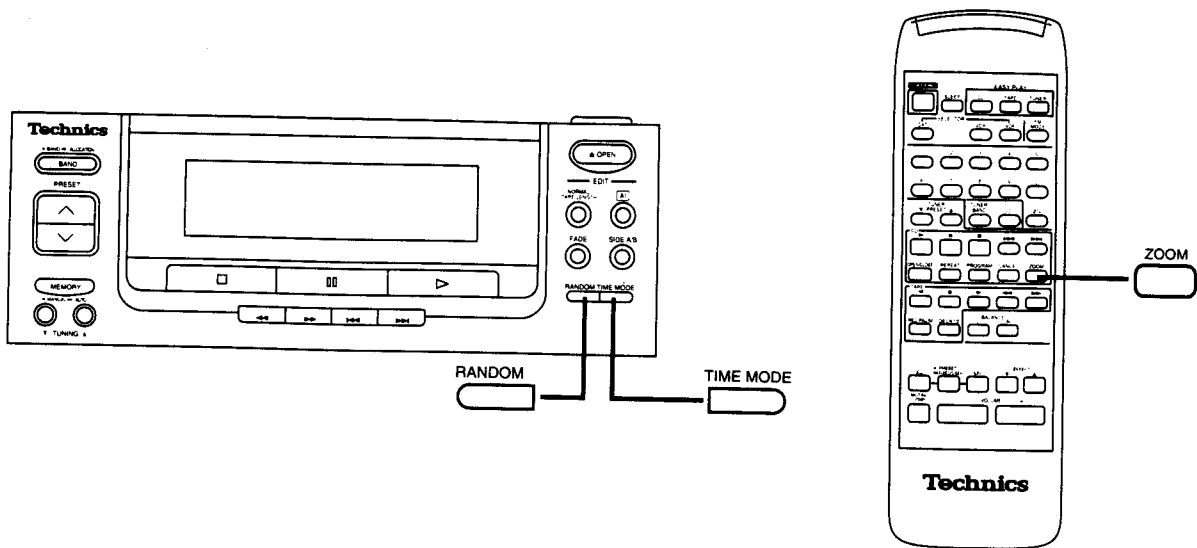

## Random play

The microcomputer will automatically select the sequence of tracks to be played in exclusively random manner.

Press the random button in the stop mode.



The random indicator will illuminate and random play will start.

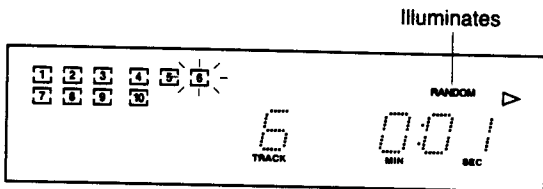

### ■ To cancel the random play

Press the random button once again and the random indicator goes out.



The sequential play will resume.

Pressing the stop button to stop the play also cancels the random play mode.

#### Note:

While the program play is taking place, only the programmed tracks will be played in random manner.

## Zoom function

When the zoom function is activated, the track number display will be enlarged.

Press the zoom button.

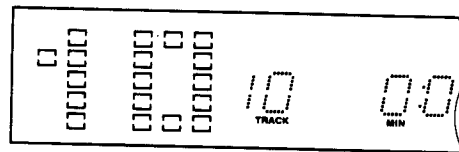

To cancel the zoom function, press the zoom button once again.

## Time mode display

Four patterns of the display mode can be alternately displayed.

Press the time mode select button during play or when the unit is in the pause mode.



Each time the time mode select button is pressed, the display changes as follows.

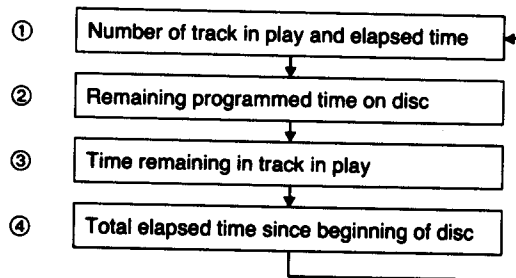

- While the track number 31 or higher is playing:  
The "----" indication will be shown on display ③.
- During random play:  
The "----" indication will be shown on display ② and the "----" on display ④.
- While the track number 31 or higher is program-playing:  
The "----" indication will be shown on display ② and ③.

# Listening to Tapes

Either tape deck 1 or tape deck 2 can be used for tape playback by following the same steps.  
(This page shows an example using deck 1.)

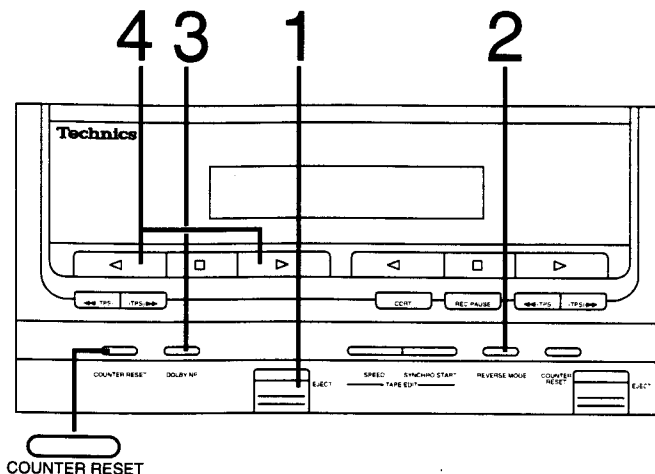

## Have you switched on the power?

Step 4 can be operated using the remote control with the procedure below.

- 1 Press the eject button, and then insert the cassette tape to be used for playback.

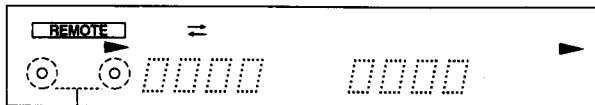

Illuminates

- The part of the cassette tape where the tape is exposed should face down-ward.
- Either normal, chrome or metal type cassette tape can be used.
- To reset the tape counter (0000), press the counter reset button.
- While the reverse side of the tape is being played back, the counter will count back. (0000-9999-9998-)

- 2 Press the reverse mode select button to select the appropriate reverse mode.

Each time the reverse mode select button is pressed, one of the three reverse mode indicators will be alternately displayed.

- : One side only will be played, and then the tape will automatically stop.
- : Both sides will be played 8 times, and then the tape will automatically stop.
- : **When a tape is loaded into only deck 1 or 2** Both sides (from forward side to reverse side) will be played, then the tape will automatically stop.  
**When tapes are loaded into both decks** Both sides (from forward side to reverse side) of the tape in deck 1 are played first, and then both sides of the tape in deck 2.  
After repeating above operation 8 times, the tape will automatically stop.

- 3 Press the Dolby noise reduction button to set the Dolby NR mode B or C in which the tape was recorded.

The Dolby noise reduction indicator (B or C) will illuminate. If the tape was not recorded in a Dolby NR mode, press the Dolby noise reduction button again and the Dolby NR indicator will go out.

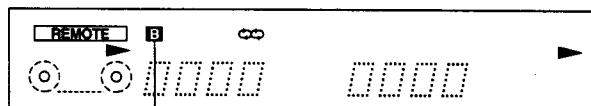

Dolby noise reduction indicator

- 4 Press the playback button to start playback.

- : The forward side (front side) will be played.
- : The reverse side will be played.

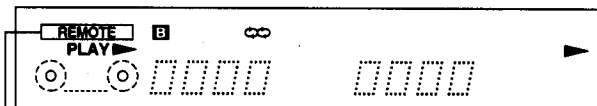

Deck 1 remote indicator

- When operating from the remote control and the tapes are loaded in both decks, press the deck 1/2 selector on the remote control to select the deck to be used. The remote indicator will illuminate to show which deck can be operated with the remote control.
- Tape direction can be reversed manually during playback by pressing the opposite of the playback button.

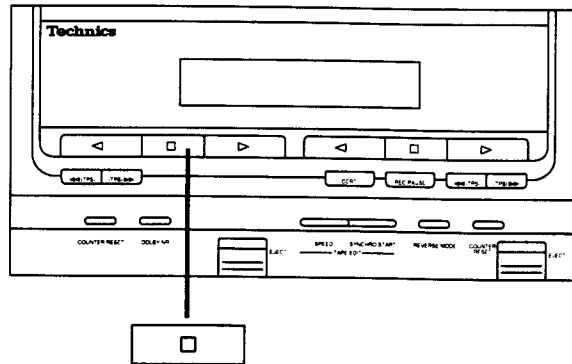
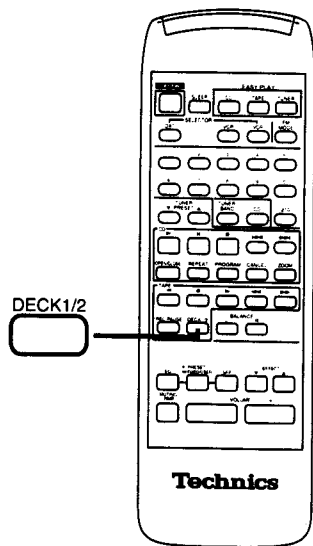

■ **To stop the tape playback**

This function can also be performed from the remote control. Follow the procedure described below.

**Press the stop button.**



When operating from the remote control and the tapes are loaded in both decks, press the deck 1/2 selector on the remote control to select the deck to be used.

■ **Auto tape selector function**

This function automatically identifies the kind of tape loaded (normal, chrome, or metal), and sets the bias (for recording) and equalization accordingly.

■ **Full auto-stop**

When the tape reaches its end, the tape movement will automatically stop.

# Listening to Tapes (continued)

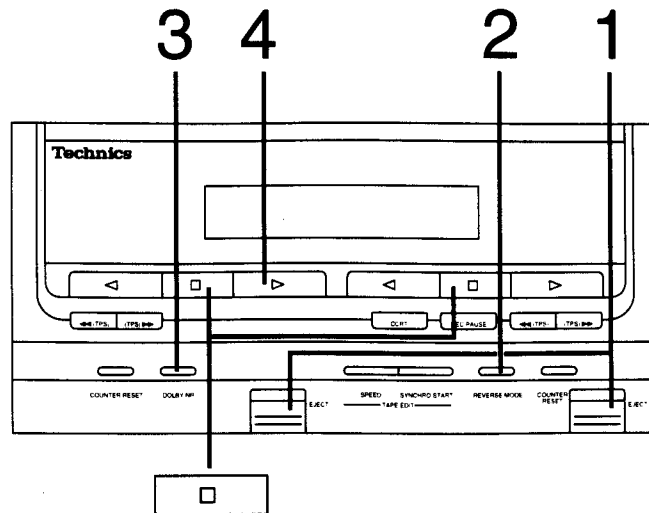

## Listening to two tapes consecutively

Step 4 can be operated from the remote control. Follow the procedure described below.

### 1 Load tapes in decks 1 and 2.

Be sure that the side that you wish to start to listen to is facing you, and load it in deck 1.

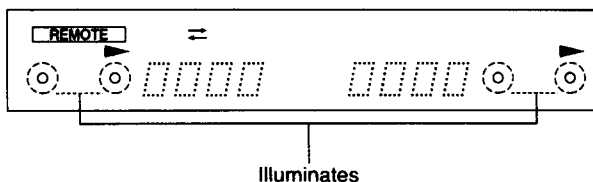

### 2 Press the reverse mode select button to set the "∞" mode.

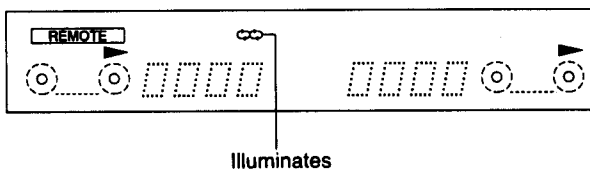

### 3 Press the Dolby noise reduction button to set the Dolby NR mode B or C in which the tape was recorded.

The Dolby noise reduction indicator (B or C) will illuminate. If the tape was not recorded in a Dolby NR mode, press the Dolby noise reduction button again and the Dolby NR indicator will go out.

It is recommended that tapes in both decks are the same type of the Dolby noise reduction.

### 4 Press the deck 1 playback button to start playback.

When operating from the remote control, first press the deck 1/2 selector on the remote control to illuminate the deck 1 remote indicator.

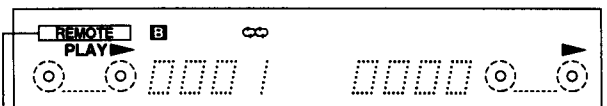

Deck 1 remote indicator will illuminate.

Two tapes will be played back as follows:

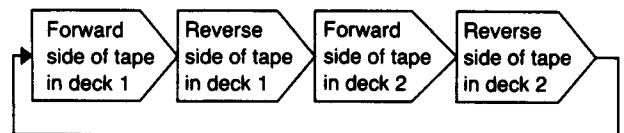

After repeating above operation 8 times, the tape will automatically stop.

### ■ To stop the tape mid-way

This function can be operated from the remote control with the procedure below.

**Press the stop button of the deck in which the tape is currently playing.**

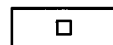

• You can also start playback from a position other than the forward side of the tape in deck 1.

• If playback is started from deck 2, the tape in deck 1 will be played back only seven times.

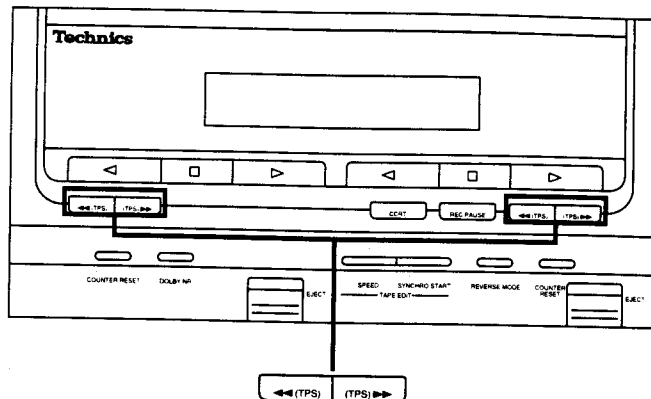

### To find the beginning of a program (TPS: tape program sensor)

This function can also be performed from the remote control. Follow the procedure described below.

(While playing the tape)

Press the fast-forward/rewind/tape program sensor button.

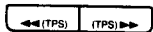

When the forward side (▷) is being played:

 .....The tape will be played from the beginning of the next program.

 .....The tape will be rewound to the beginning of the present program, then the program will be played again.

While a TPS operation is taking place, the playback indicator will flash.

When the reverse side is being played:

The reverse operation should be taken place.

#### Notes:

The TPS function may sometimes fail to operate correctly in the following cases:

- When the interval between program (the non-recorded part) is less than 4 seconds.
- When a tape has been recorded with fade-ins and fade-outs.
- When there is a particularly low level passage or silent passage in the middle of a program.
- When a tape recorded from a microphone is being played back (and there are no unrecorded blanks between the tape programs).
- When less than 10 seconds remain until the start of the next program.

### To fast forward or rewind the tape

This function can also be performed from the remote control. Follow the procedure described below.

Press the fast-forward/rewind/tape program sensor button in the stop condition.

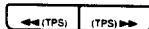

The tape will start moving at high speed in the direction of the arrow (◀, ▶), regardless of which side is being played back.

### Concerning the fade-in and fade-out

The volume level will gradually increase (fade in)

The volume level will gradually decrease (fade out)

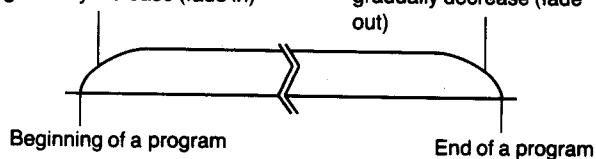

# Listening to Radio Broadcasts

When broadcast frequencies have been preset to the memory, any of those broadcast frequencies can thereafter be easily selected by simply pressing one of the numeric buttons on the remote control or using the preset tuning buttons on the CD player/tuner.

You can memorize up to 30 radio stations into the unit's memory. "Channels" 1 to 30 are available for the presetting of FM stations, and "channels" 21 to 30 are available for MW stations, and "channels" 29 to 30 are available for LW stations.

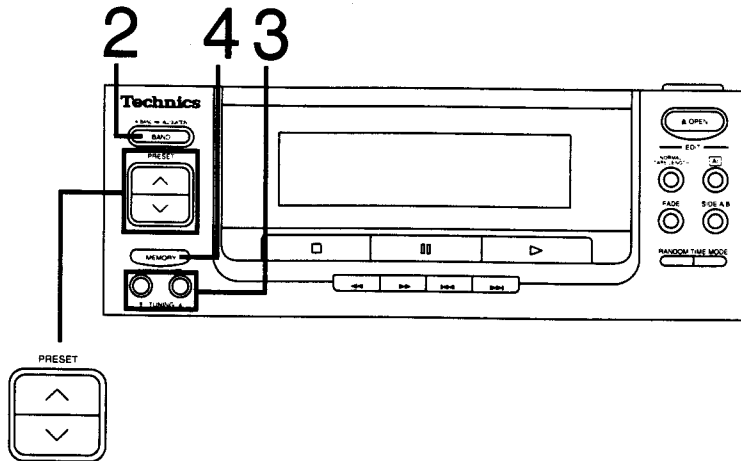

## Automatic memory presetting

Step 1 and 2 can be operated from the remote control. Follow the procedure below.

When this method is used, the frequencies of the selected broadcast stations are automatically preset (in sequence from low to high frequencies) in memory.

Have you switched ON the power?

- 1 Press the input select button marked "TUNER" on the amplifier.
- 2 Press the band select button to select the desired band (FM/MW/LW).  
Each time you press the band select button, the FM, MW and LW indicators will be alternately displayed.
- 3 Press and hold one of the tuning buttons until the display shows the lowest frequency.

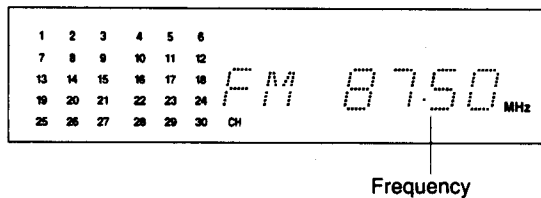

- 4 Press and hold the preset memory button to start the memory.  
Keep the memory button depressed until the memory indicator starts flashing, then release the button.  
After completing the memory presetting, the memory indicator will go out and the display will show the last preset frequency.

■ To confirm the stations which are preset to each channel

Press one of the preset tuning buttons.

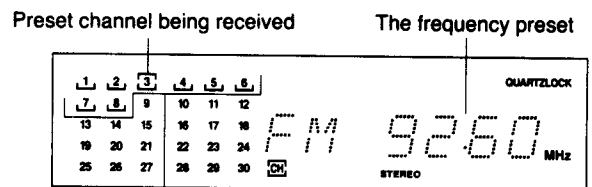
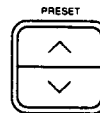

Preset channels of FM stations

### Notes:

- A particular station may not have been memorized when using the auto memory function for variety of reasons. Use the manual memory functions to memorize stations not captured using auto memory.
- When a new frequency is memorized in a channel, the frequency previously memorized in that channel will be cancelled.

### ■ MW allocation

When the band select button is pressed for about 3 seconds in MW band, MW frequency step will change to 10 kHz per step. If you press and hold this button, it will be switched to 9 kHz per step and vice versa.

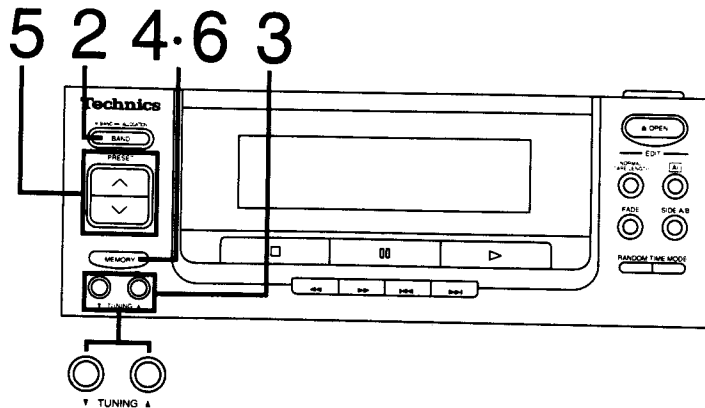

## Manual memory presetting

Bands and stations can be freely preset to any desired channel. A maximum of 30 broadcast stations can be memorized.

Step 1, 2 and 5 can be operated from the remote control. Follow the procedure described below.

**1 Press the input select button marked "TUNER" on the amplifier.**

**2 Press the band select button to select the desired band (FM/MW/LW).**

Each time you press the band select button, FM, MW and LW indicator will be alternately displayed.

**3 Press one of the tuning buttons to tune to the desired broadcast.**

(Refer to "Automatic scanning" at right side of this page.)

Each time you press one of the tuning buttons, the frequency display will change as follows:

FM: 0.05 MHz

MW: 9 kHz or 10 kHz

LW: 9 kHz

**4 Press the preset memory button momentarily.**

The memory indicator will illuminate.

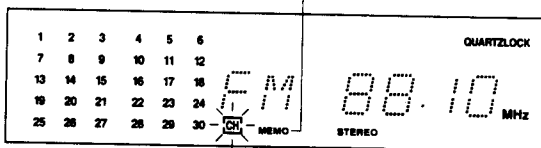

The channel indicator will flash.

**5 Press one of the preset tuning buttons to select the desired preset channel.**

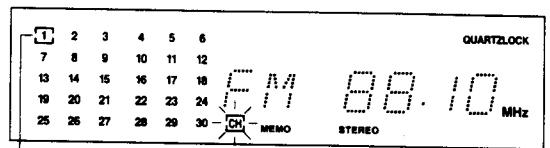

Preset channel

**6 Press the preset memory button momentarily.**

Once the desired station has been memorized, the memory indicator will no longer illuminate.

The channel indicator will stop flashing.

### Automatic scanning

You can make an automatic tuning using the tuning buttons.

**Press and hold one of the tuning buttons until the displayed frequency begins to change.**

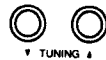

The changing of the displayed frequency will be automatically stopped if a broadcast station frequency is located during the tuning process.

To cancel the automatic scanning, press one of the tuning buttons once again.

If there is much noise caused by interference, the automatic scanning may not function.

# Listening to Radio Broadcasts (continued)

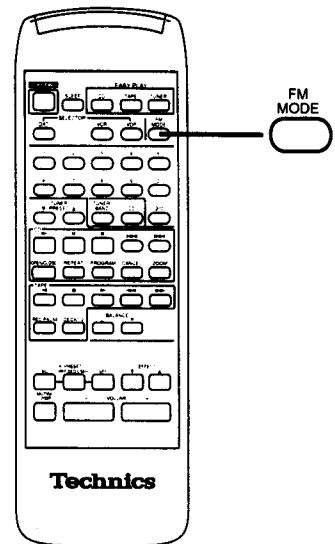
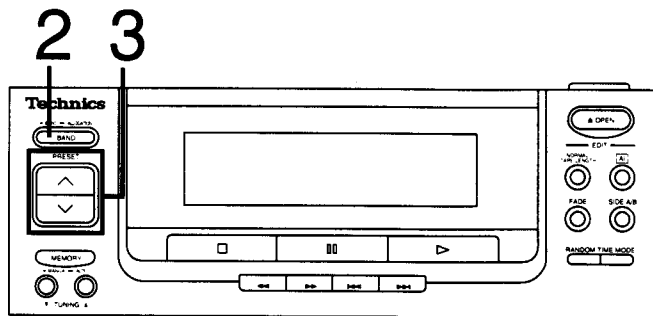

## Memory tuner operation

(to listen to broadcast stations preset into memory)

Have you performed the steps of "Automatic memory presetting" on page 38 or "Manual memory presetting" on page 39?

This function can also be performed from the remote control. Follow the procedure described below.

- 1 Press the input select button marked "TUNER" on the amplifier.
- 2 Press the band select button to select the desired band (FM/MW/LW).  
Each time you press the band-select button, the FM, MW and LW indicator will be alternately displayed.
- 3 Press one of the preset tuning buttons to select the desired preset channel.  
The selected preset channel will illuminate.

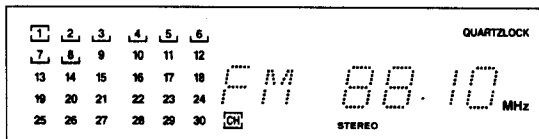

### Note:

If the noise is picked up when a video disc player is connected to this system, switch off a video disc player.

## ■ To change the FM mode

Press the FM mode button to monaural position.



The FM stereo indicator will change to "MONO".

The sound will then be heard in monaural. If the broadcast signal is weak, or if there is a large amount of interference, sounds can be heard more clearly.

## ■ Most recent memory

The most recent memory system "remembers" the broadcast station last tuned to when the power is switched to standby mode or other functions are selected. The last tuned station will be heard when the unit is switched "ON" or the tuner source is selected.

Memory presetting is maintained for approximately 2 weeks even if the unit is in the standby mode.



# Making a Recording (Deck 2 only)

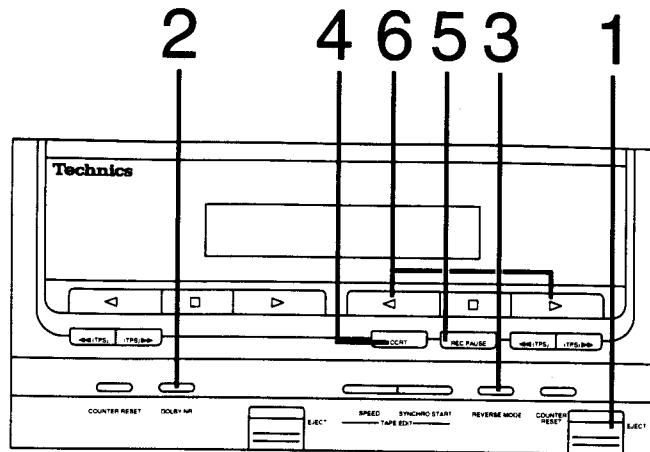

## To record the desired source

Although you can record a compact disc using the following procedure, it is recommended that you use the handy compact disc edit-recording procedure. (See page 45-51.)

To make a tape-to-tape recording, see "Tape-to-Tape Recording" on page 52.

Steps 5 and 6 can be operated using the remote control with the procedure below.

**1 Press the deck 2 eject button to load a tape in deck 2.**

You cannot record on the leader tape, so take up the leader tape in advance.

**2 When making a Dolby NR recording, press the Dolby noise reduction button to illuminate the Dolby NR indicator "B" or "C".**

**3 Select the reverse mode using the reverse mode select button.**

: One side will be recorded, then the tape will automatically stop.

: Both sides will be recorded (forward side-reverse side), then the tape will automatically stop.

**4 When making a CCRT recording, press the CCRT button to illuminate the CCRT indicator.** (See page 42.)

When the CCRT mode is activated, the test signal for adjustment will be recorded on the tape, so the previous recording will be automatically erased.

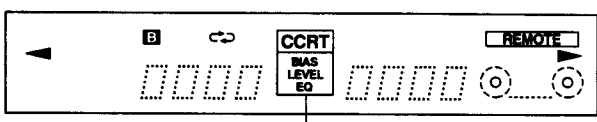

CCRT indicator will illuminate.

**5 Press the record/record standby button to put the cassette deck into the recording standby state, then press the input select button of the source to be recorded.**  
The playback indicator will flash.

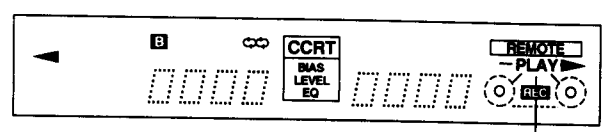

Recording indicator

**6 Press one of the playback buttons to start recording, then start playing the source to be recorded.**

- : When recording on either the forward side or both sides
- : When recording only on the reverse side

- Notes:**
- Do not press the input select buttons while the CCRT mode is activated.
  - To press the eject button in the power on condition after the CCRT setting is completed makes the CCRT mode cancel.
  - Do not press the disc tray open/close button while recording. It releases the recording condition.

**■ Synchro start function**  
When you make a recording from a compact disc, the recording will automatically start when you press the play button on the compact disc player section in the recording standby state. After recording has been completed, the cassette deck will create a non-recorded passage of about 4 seconds, and then go into the recording standby state.

**■ If the "-E-" indication is displayed on the cassette deck display**  
An "-E-" will appear in tape counter if the cassette deck is not ready to record because the safety tab has been broken off. Correct the problem and then repeat the procedure from step 4.

# Making a Recording (continued)

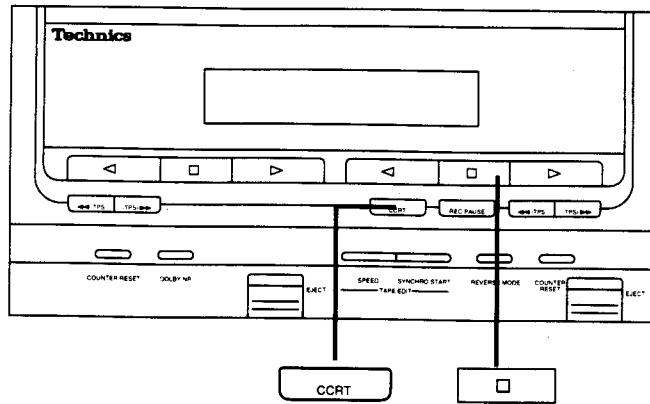

## CCRT recording function

CCRT (Computer Control Record Tuning) is the function which identifies the quality of the tape (concerning bias, level, equalizer) automatically and sets the most desirable recording condition. It takes about 1 minute to complete the setting. The display changes as follows while the CCRT setting is taken place.

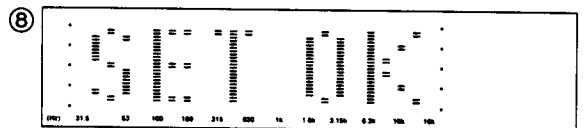
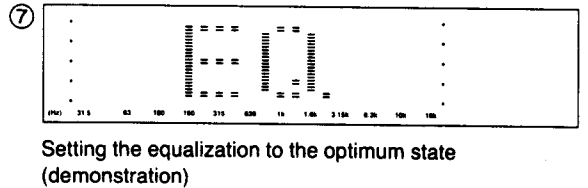
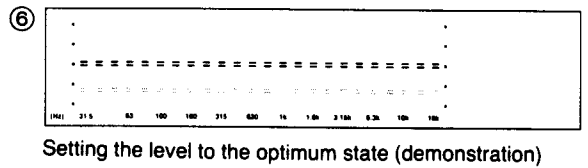
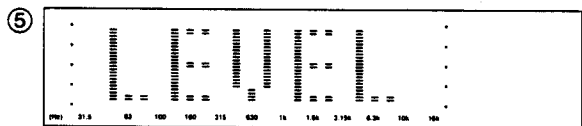
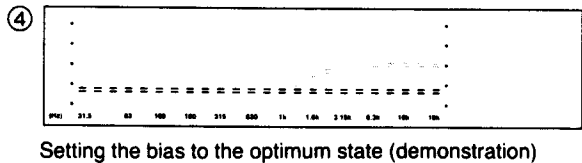
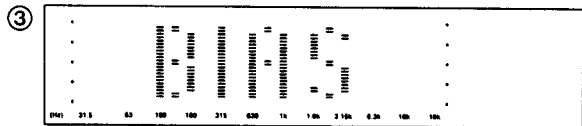
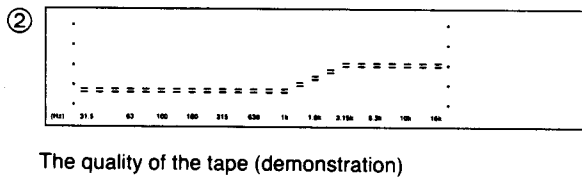
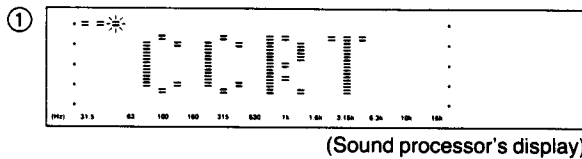

### Notes:

- You cannot make the CCRT setting at the end of the cassette tape.
- The setting may not be possible with the old cassette tape or special kind of tape.
- The CCRT setting is memorized after the power is switched to the standby condition. In case you record on another tape, cancel the memorized CCRT setting or re-set the CCRT.

**■ To cancel the CCRT setting on the way  
Press the stop button.**



The CCRT indicator will go out.

**■ To cancel the CCRT mode  
Press the CCRT button.**

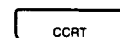

The CCRT indicator will go out.

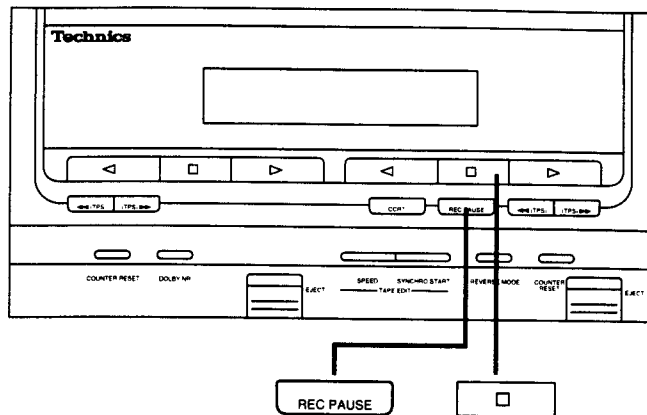

## Dolby NR system

This is a system intended to reduce hiss noise in the high frequency range. It raises the level of the high frequency components during recording, and lowers it by the same amount during playback.

**B type:** Noise is reduced to about  $\frac{1}{3}$ . Use this type when playing a tape in the Dolby NR mode.

**C type:** Noise is reduced to about  $\frac{1}{10}$ . Use this type when recording and playing back a high quality, high dynamic range source such as a compact disc or FM broadcast.

Dolby noise reduction and HX Pro headroom extension manufactured under license from Dolby Laboratories Licensing Corporation. HX Pro originated by Bang & Olufsen.

"DOLBY", the double-D symbol  and "HX PRO" are trademarks of Dolby Laboratories Licensing Corporation.

## To briefly interrupt recording

This function is also available from the remote control. Follow the procedure described below.

**Press the record/record standby button.**

 REC PAUSE

The cassette deck will go into the recording standby state. To resume recording, press the play button corresponding to the direction in which recording is taking place.

## To stop recording

This function can also be performed from the remote control. Follow the procedures described below.

**Press the stop button.**



## Concerning the leader tape

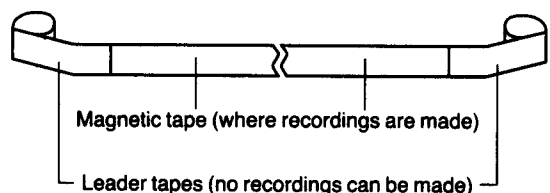

# Making a Recording (continued)

## ■ To erase a recorded tape (Deck 2)

When new recordings are made on a pre-recorded tape, all sounds recorded on that portion of the tape are automatically erased. To erase a tape without making a new recording, follow the steps below.

Steps 5 and 6 can be operated using the remote control with the procedure below.

- 1) Press the Dolby noise reduction button to turn off the Dolby noise reduction indicator.
- 2) Insert the recorded tape into the cassette holder of deck 2.
- 3) Press the input select button marked "TAPE" on the amplifier.
- 4) Select the desired reverse mode.
- 5) Press the record/record standby button.
- 6) Press the playback button corresponding to the side to be erased.

## ■ To record with desired tone and effect

You can make a recording with the graphic equalizer and/or surround sound effect. (See page 58–66.)

When playing back such recordings, press the equalizer ON/FLAT button to set "FLAT" and press the SFP OFF/ON button to go off the SFP indicator.

# Edit-Recording from Compact Discs

Up to 30 tracks can be edit-recorded.

Use of the unit's edit-recording functions safeguard against a break in the continuity of the sound when the recording changes from one side of the tape to the other (except "Fade-in edit recording").

In any of the following edit-recording functions, you can record with desired tone and effect.

See "Creating Your Own Sound" on page 58-66.

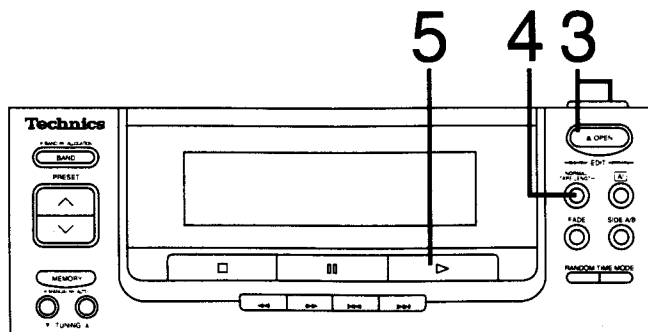

## Sequential editing

This function allows for automatic recording of compact disc tracks sequence. At the end of each side of the tape, the song that will not fit completely will be faded out, a song faded out on side "A" will be recorded from the beginning on side "B". During recording, silent gaps of approximately 4 seconds are inserted between tracks automatically (auto space function).

A tape such as follows will be made:

Faded out at the end of side A

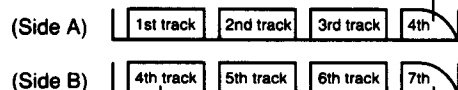

The track that has been faded out at the end of side A

Faded out if the tape ends in the middle of the track

### Have you switched on the power?

#### 1 Load a tape in deck 2.

When making a Dolby NR recording, press the Dolby noise reduction button to select "B" or "C".

Recording will progress automatically from the forward side to the reverse side of the tape, so insert the tape with the side from which you intend to record first facing toward you, then select the "↺" reverse mode.

#### 2 Press the input select button marked "CD" on the amplifier.

#### 3 Press the disc tray open/close button to load a disc.

#### 4 Press the normal/tape length edit button once to indicate "C-AUTO".

The cassette deck will rewind the tape and then take up the leader tape automatically and the "CD" edit indicator will illuminate. The CCRT function (see page 42) will be automatically activated.

When you want to record programmed tracks, first program tracks in memory using the program play procedure (see page 30) before pressing the normal/tape length edit button.

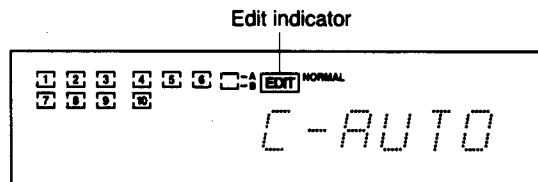

#### 5 Press the play button.

The ATLS function (see page 51) will operate to adjust the recording level, and then recording will start.

When edit-recording has finished, the cassette deck automatically enters the recording standby mode.

When the link indicator illuminates, it is possible to record another disc on the tape leftover using the sequential editing (see page 51). If another disc is not going to be recorded, press the stop button on the CD player/tuner.

The CCRT function will active in the CD edit recording mode. However, according to the types of the cassette tape, the CCRT function may not activate correctly. In this case, press the power "STANDBY/ON" switch to the standby mode, and replace the cassette tape. The CCRT function also may not activate when the heads of the cassette deck is dirty. (To clean the head, see page 73.)

Your attention is drawn to the fact that recording pre-recorded tapes or discs on other published or broadcast material may infringe copyright laws.

# Edit-Recording from Compact Discs

(continued)

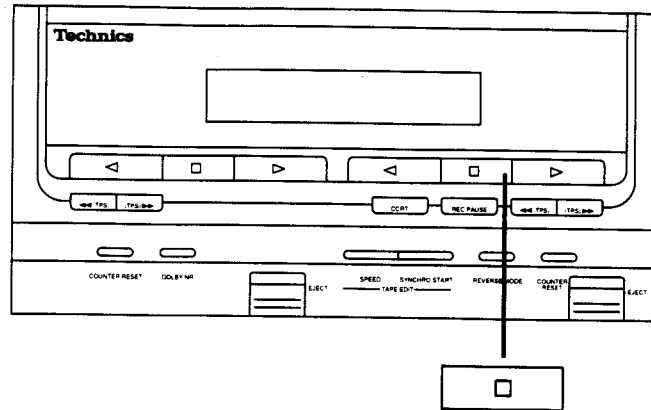

■ **To cancel the sequential editing**

**Press the stop button.**



The compact disc play will automatically stop.

■ **If the “-E-” indication is displayed on the cassette deck display**

An “-E-” will appear in tape counter if the cassette deck is not ready to record because the safety tab has been broken off. Correct the problem, and then repeat the procedure from step 4.

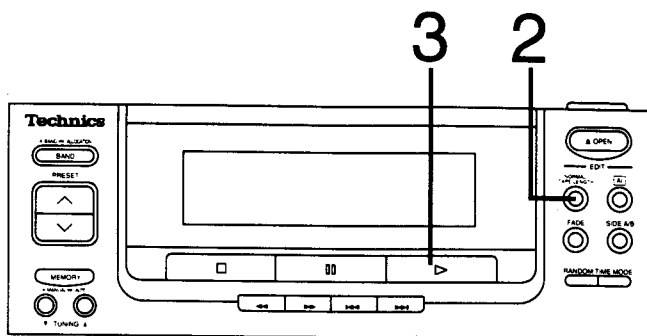

## Tape length editing

Like the "Sequential editing" function on the page 45, this function allows for automatic recording of compact disc tracks in sequence, on a tape which you specify its length. However, at the end of each side of the tape, instead of fading out the song, the tape is left blank unless the next entire song in the sequence will fit.

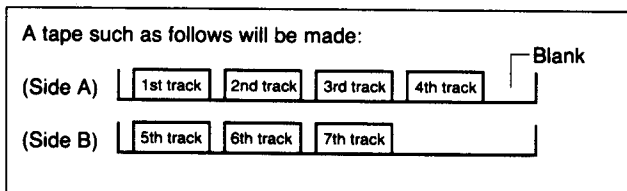

- 1 Follow steps 1, 2 and 3 on page 45.
- 2 Press the normal/tape length edit button to select the tape length.  
Each time the button is pressed the multi display changes as follows.

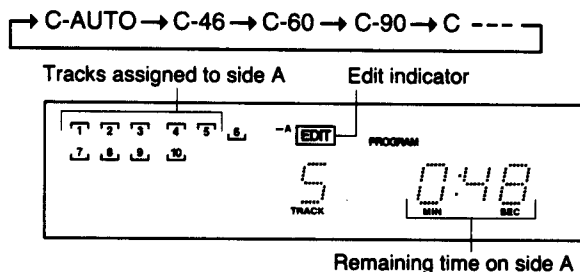

The cassette deck will rewind the tape and then take up the leader tape automatically and the "CD" edit indicator will illuminate.

The CCRT function (see page 42) will be automatically activated.

When you want to record programmed tracks, first program tracks in memory using the program play procedure (see page 30) before pressing the normal/tape length edit button.

■ **To specify a tape length other than C-46, 60, 90**  
Press the normal/tape length edit button 5 times to select "C----". Then press the numeric buttons on the remote control to specify the total recording time of the tape. (1~99 minutes)

**For example:**  
To select 64 minutes: [6] - [4]

From the main unit, keep pressing one of the skip buttons until the display shows the desired tape length.

- 3 **Press the play button.**  
The ATLS function (see page 51) will operate to adjust the recording level and then recording will start.

When edit-recording has finished, the cassette deck automatically enters the recording stanby mode.

When the link indicator illuminates, it is possible to record another disc on the tape leftover using the tape length editing (see page 51). If another disc is not going to be recorded, press the stop button on the CD player/tuner.

# Edit-Recording from Compact Discs

(continued)

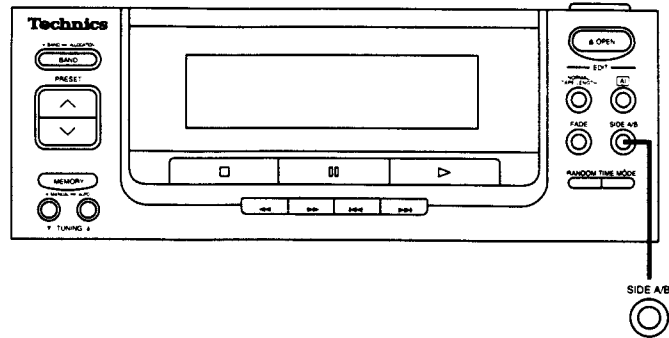

## ■ To cancel the tape length editing

**Press the stop button on the cassette deck.**

The compact disc play will automatically stop.

## ■ If the “-E-” indication is displayed on the cassette deck display

An “-E-” will appear in tape counter if the cassette deck is not ready to record because the safety tab has been broken off. Correct the problem, and then repeat the procedure from step 2.

## To confirm the edited program on side A and B

This button is used for checking the number of tracks edited and the time leftover on side A and B when making the tape length editing.

**Press the tape-side select button before starting the compact disc play.**



The track number that can be recorded on side B

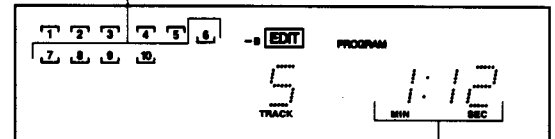

Remaining time on side B



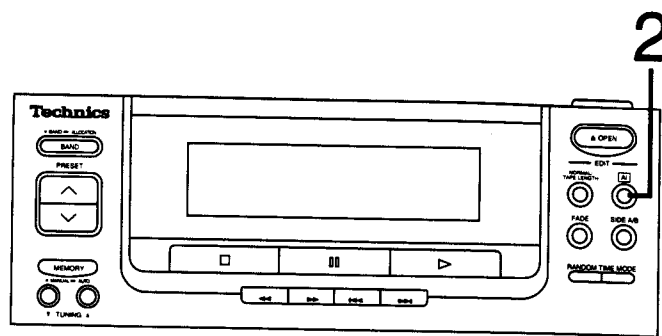

**One touch editing (AI function)**

The AI (Artificial Intelligence) function will rearrange the compact disc tracks order to minimize leftover tape at the end of side "A" of your cassette.

The tape is advanced and then rewound in order to measure its length. This is done so that the compact disc player can estimate which song order best fits on side "A". After recording has been completed on side "A", the compact disc player accurately determines the amount of leftover blank tape. If the amount of blank tape is great, the tape deck rewinds the tape end and the compact disc player selects a different track order that best fits on side "A".

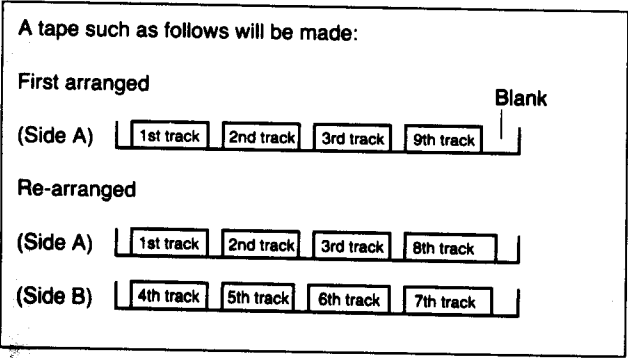

**1** Follow steps 1, 2 and 3 on page 45.

**2** Press the AI edit button.

Just pressing this button activates the one touch editing.

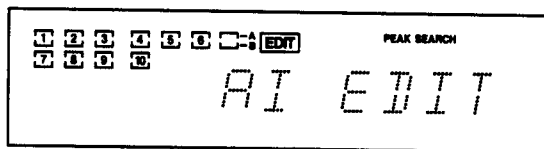

The CCRT function (see page 42) will be automatically activated.

The cassette deck automatically fast-forwards and rewinds the tape to measure the tape length.

During this period, the ATLS function (see page 51) will operate to automatically adjust the recording level.

The CD player/tuner's display will flicker. This is normal.

The tape deck automatically advances the tape until the leader portion of the tape has been wound; recording starts from that point on.

When edit-recording has finished, the cassette deck automatically enters the recording standby mode.

When the link indicator illuminates, it is possible to record another disc for some more time on the tape using tape length editing (see page 51). If another disc is not going to be recorded, press the stop button on the CD player/tuner.

**Notes:**

- It is not possible to make a one touch editing for one track and a track number of 31 or more.
- Use a tape of less than 99 minutes.

**■ To cancel the one touch editing**

**Press the stop button on the cassette deck.**

The compact disc play will automatically stop.

**■ If the "-E-" indication is displayed on the cassette deck display**

An "-E-" will appear in tape counter if the cassette deck is not ready to record because the safety tab has been broken off. Correct the problem, and then repeat the procedure from step 2.

# Edit-Recording from Compact Discs

(continued)

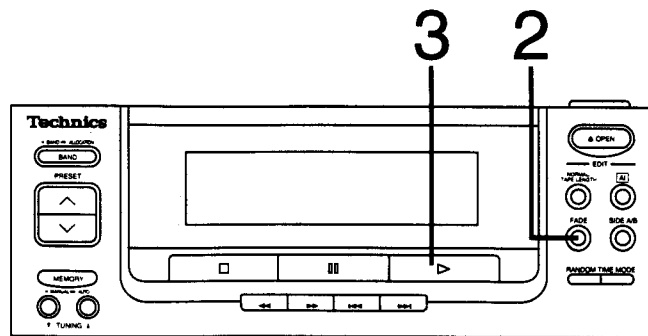

## Fade-in edit recording

The unit makes a tape with no blanks between the tracks. It is convenient to make an original dance-music tape.

A tape such as follows will be made:  
Faded in at the start of the track

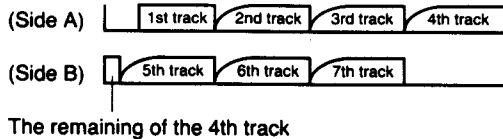

- 1 Follow steps 1, 2 and 3 on page 45.
- 2 Press the fade-in edit button.

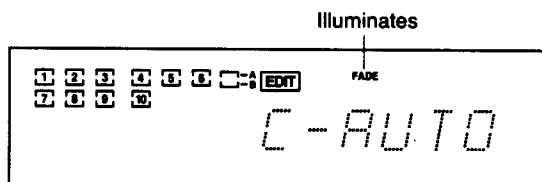

The cassette deck will rewind the tape and take up the leader tape automatically and the "CD" edit indicator will illuminate. The CCRT function (see page 42) will be automatically activated.

When you want to record programmed tracks, program tracks using the program play procedure (see page 30) before pressing the fade-in edit button.

- 3 Press the play button.  
The ATLS function (see page 51) will operate to adjust the recording level and then recording will start.

When edit-recording has finished, the cassette deck automatically enters the recording standby mode.

When the link indicator illuminates, it is possible to record another disc for some more time on the tape using the fade-in editing (see page 51). If another disc is not going to be recorded, press the stop button on the CD player/tuner.

### ■ To cancel the fade-in edit recording

Press the stop button on the cassette deck.  
The compact disc play will stop automatically.

### ■ If the "-E-" indication is displayed on the cassette deck display

An "-E-" will appear in tape counter if the cassette deck is not ready to record because the safety tab has been broken off. Correct the problem, and then repeat the procedure from step 2.

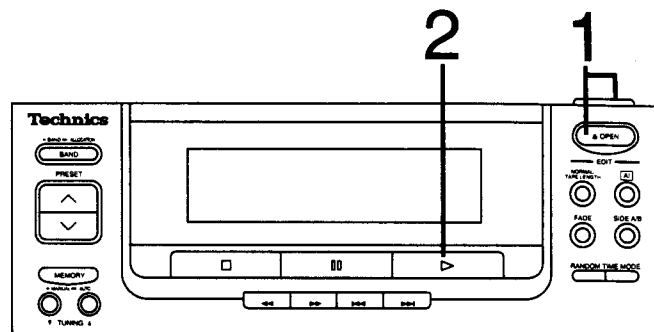

## Link edit-recording

When recording of the first disc has finished and the link indicator illuminates, the tracks of another disc can be recorded.

(After recording of the first disc has finished)

### 1 Press the disc tray open/close button to open the disc tray and then replace the disc.

Tracks to be recorded on the tape left will be automatically calculated and displayed.

Tracks that can be recorded on side B

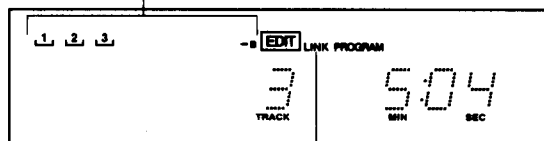

The link indicator will illuminate

### 2 Press the play button to start recording.

After the recording level has been automatically adjusted, the recording will start.

#### Notes:

- If there is not enough space at the end of the tape, it may not be able to record on the tape left.
- In case you record more than third discs, follow the above procedures.
- After finishing the recording the first disc using the sequential editing or fade-in editing, tracks to be recorded on the tape will not be displayed, but it is possible to record another disc.
- When the first disc has been edited using the AI function, you can not make a link edit-recording from tape side A to B.

### ■ To cancel the link edit-recording

This function can also be performed from the remote control. Follow the procedure described below.

**Press the stop button on the cassette deck.**

## ATLS (Automatic Tape Level Setting)

The unit automatically searches for the peak point of the entire disc or the programmed tracks.

When the peak point is found, the peak signal will be sent for about 7 seconds, and the recording level will be set automatically at the cassette deck. (During this interval, the peak sound will not be output.)

# Tape-to-Tape Recording

The recording level of the original (playback) tape, and the noise reduction effect on the original tape, will be recorded to the new tape just as they were in the original recording.

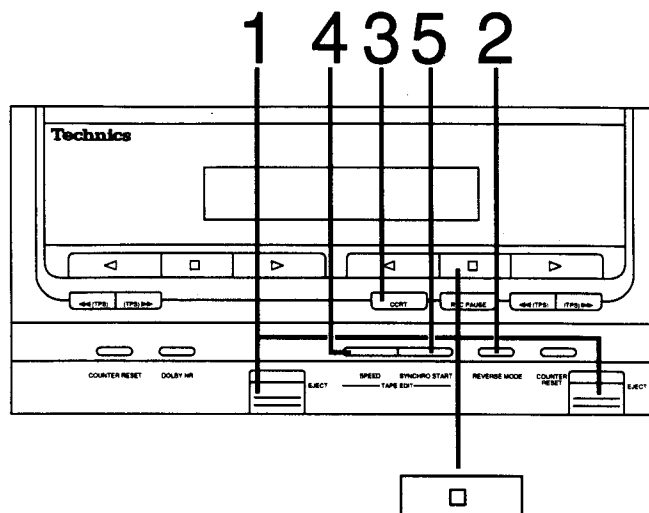

## To record from deck 1 to deck 2

It is recommended that you use the editing tape of the same or higher quality than the playback tape.

**Have you switched on the power?**

**1 Insert the playback tape into deck 1 and the editing tape into deck 2.**

**2 Select the desired reverse mode.**

→ : Single sided recording (forward side only)

↔ : Two sided recording

(forward side → reverse side)

In case the length of a tape set in deck 2 is longer than a tape in deck 1, deck 1 repeats the playback until deck 2 completes the two-sided recording. (up to eight times)

↔ : Two sided recording

(forward side → reverse side)

**3 When making a CCRT recording, press the CCRT button to illuminate the CCRT indicator.**

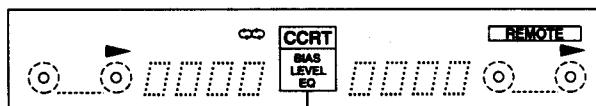

Illuminates

**4 Press the edit speed select button to select the recording speed "×1" or "×2".**

×1: Select this mode when you wish to listen to the sound while recording

×2: Select this mode when you wish to record with high-speed

**5 Press the synchro start button to start tape-to-tape recording.**

When deck 1 stops, the deck 2 automatically creates a non-recorded passage of about 4 seconds in length, and then enters the recording standby mode.

When deck 2 stops, deck 1 stops simultaneously.

While tape-to-tape recording is in progress, you can press one of the input select buttons on the amplifier and enjoy listening to another music source, such as a compact disc. You can change the settings of the volume and tone controls of the sound processor without affecting the recording.

### ■ To cancel the tape-to-tape recording

**Press the stop button on deck 2.**

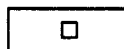

Deck 1 will be also stopped.

When you press the stop button on deck 1 during tape-to-tape recording, deck 2 will be entered the recording standby mode after creating a non-recorded passage of about four seconds. To resume the tape-to-tape recording, press the synchro start button.

### Notes:

- Be sure to press the edit speed select button to go out the edit speed indicator after finishing tape-to-tape recording.
- Switch off your television set or video equipment when performing tape-to-tape recording at high speed (×2). The reason for this is that noise is sometimes picked up and recorded.



# Using the Timer (continued)

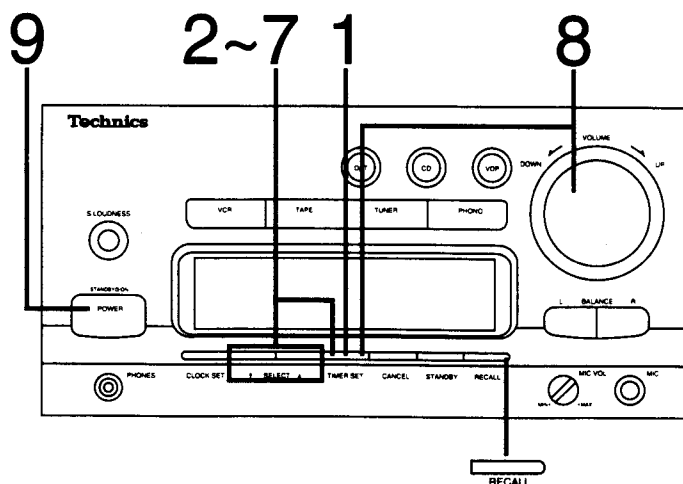

## Setting the timer play

Have you completed "Setting the Time" on page 27 and "Automatic memory presetting" on page 38 or "Manual memory presetting" on page 39? If not, please complete these sections before continuing.

The following example will show how to set the timer play function for listening to channel 3 from 6:30 to 7:15 a.m. on Saturday.

- 1 Press the timer set button to enter the timer set mode.

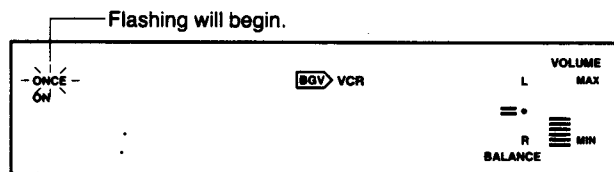

- 2 Select the types of the timer function "ONCE" or "WEEKLY".

- 1 Press one of the timer select buttons to select "ONCE".

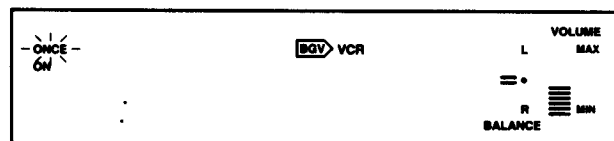

- 2 Press the timer set button.

- 3 Select the day.

- 1 Press one of the timer select buttons to select "SAT".



- 2 Press the timer set button.

- 4 Set the ON time.

- 1 Press one of the timer select buttons to select "6".



- 2 Press the timer set button.

- 3 Press one of the timer select buttons to select "30".



- 4 Press the timer set button.

## 5 Select the desired source.

- 1 Press one of the timer select buttons to select tuner source.

Each time you press one of the timer select buttons, "CD", "TAPE" and "TUNER" is alternately displayed.

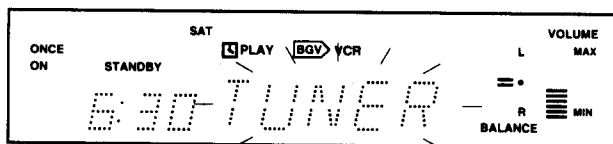

- 2 Press the timer set button.
- 3 Press one of the timer select buttons to select channel "3".  
(Only when the tuner source is selected)

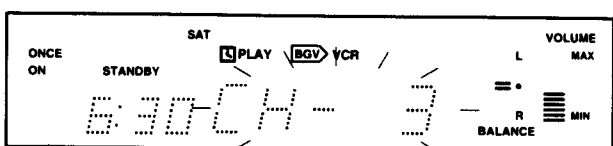

- 4 Press the timer set button.

## 6 Select the type of timer operation "PLAY" or "REC". (Only when the tuner source is selected)

- 1 Press one of the timer select buttons to select "PLAY".

Each time you press one of the timer select buttons, "PLAY" and "REC" is alternately displayed.

- 2 Press the timer set button.

## 7 Set the OFF time.

- 1 Press one of the timer select buttons to select "7".

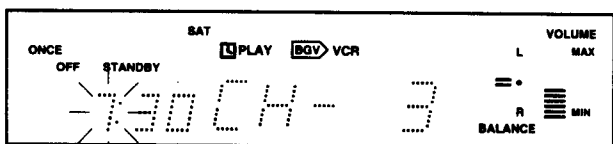

- 2 Press the timer set button.
- 3 Press one of the timer select buttons to select "15".
- 4 Press the timer set button.

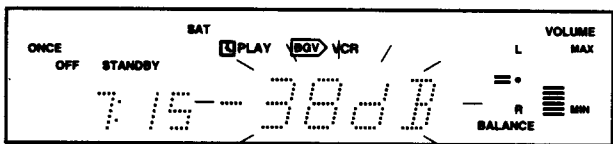

## 8 Adjust the volume level for timer play.

- 1 Adjust the volume level using the volume level control.

- 2 Press the timer set button.

The volume level memorized will activate at timer play, even if the volume setting is changed after the above procedures have been followed.

•When setting the timer recording, skip this step.

## 9 Switch the power to standby mode.

### To confirm the timer setting

Press the timer setting confirmation button.

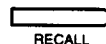

Each time you press the timer setting confirmation button, the display will change as follows:

- 1 "ONCE" power-ON time

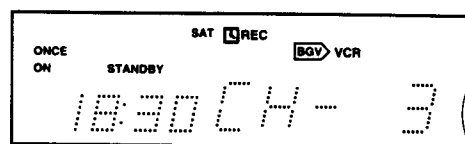

- 2 "ONCE" power-OFF time

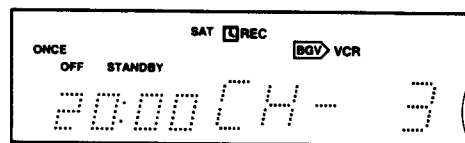

- 3 "WEEKLY" power-ON time

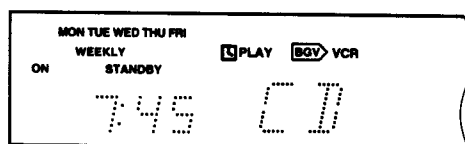

- 4 "WEEKLY" power-OFF time

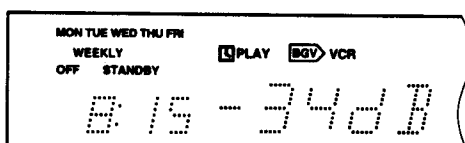

- 5 Present time

### To change the timer setting

- 1) Press the power "STANDBY/ON" switch to switch on the power.
- 2) After selecting "ONCE" or "WEEKLY" press the timer set button to proceed to the step you want to change.
- 3) Press one of the timer select buttons to change the setting.
- 4) Press the timer set button to proceed to step 8.
- 5) Switch the power to standby mode.

### Note:

•You can confirm the timer setting in the power standby condition.

# Using the Timer (continued)

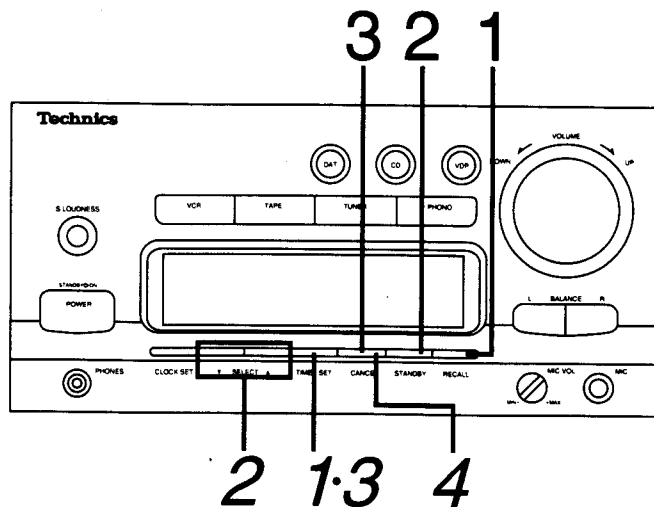

## To cancel the timer setting temporarily

- 1 Press the timer setting confirmation button to select "ONCE" or "WEEKLY".

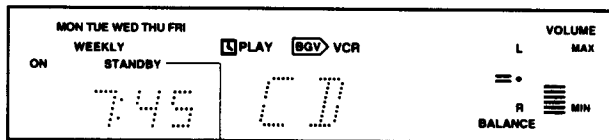

The timer standby indicator illuminates.

- 2 Press the timer standby button to go off the timer standby indicator.
- 3 Press the timer cancel button. The display will return to the clock mode.

### ■ To reset the timer setting

- 1) Press the timer setting confirmation button.
- 2) Press the timer standby button. (The timer standby indicator will illuminate.)
- 3) Press the timer cancel button to return to the clock mode.
- 4) Press the power switch to standby mode.

## To cancel the timer setting

- 1 Press the timer set button.

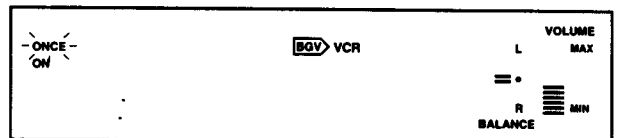

- 2 Press one of the timer select buttons to select "ONCE" or "WEEKLY".
- 3 Press the timer set button.
- 4 Press the timer cancel button to return to the clock mode.



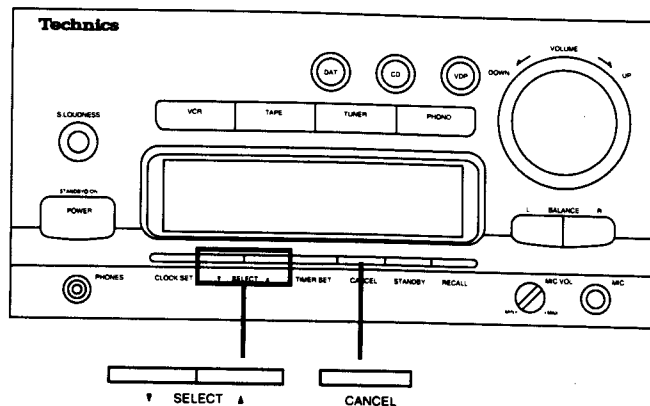
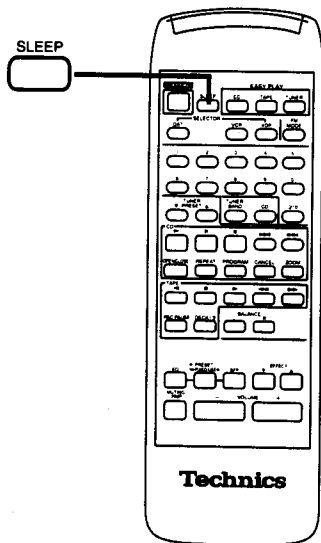

## To use the sleep timer

This timer function is used to switch the power to the standby mode at the desired time. (within a range of 120 minutes to 1 minute from the present time.)

(While the source is being played)

**Press the sleep timer button to illuminate the sleep indicator.**



The sleep indicator will illuminate.

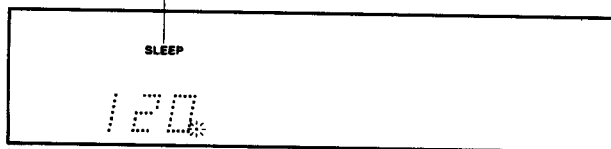

The power will be switched to standby mode after 120 minutes.

## To change the sleep timer setting

You can change the sleep timer setting in 1-minute steps. The sleep timer setting is retained until the new settings will be made.

**Press one of the timer select buttons to set the time.**

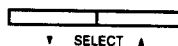

## To cancel the sleep timer setting

**Press the sleep timer button or the timer cancel button.**

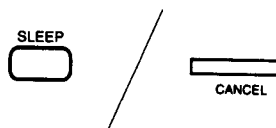

## To use the sleep timer in conjunction with the timer play operation

You can go to sleep listening to the radio broadcasts, and wake up the next morning listening to a compact disc.

- 1) Make the timer setting for a compact disc.
- 2) Tune to your favorite station and set the desired volume level.
- 3) Make the sleep timer setting with the above procedure.

# Creating Your Own Sound

Six types of sound quality (equalization curve) and six types of surround sound (SFP=Sound Field Processor) is pre-programmed to this unit. You can create your own live performance sound by adjusting the frequency level and tone, and also store them as five types 'USER' mode sounds.

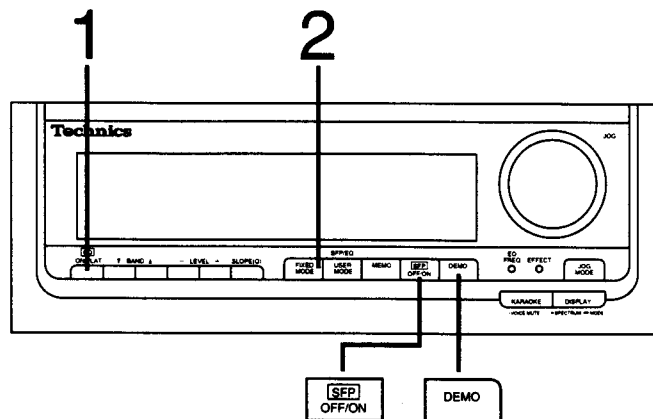

## Demonstration function

This unit comes with a factory programmed demonstration mode (adjustment example). Use this function for reference of the adjustments of equalization curves and surround sounds.

### Have you switched on the power?

(While playing the desired source,)

**Press the demonstration button.**



The six types of equalization curve and the surround sound will be displayed alternately. For the types of the equalization curve and surround sound modes, see page 60 and 63. The sound quality will be changed in sequence as described below.

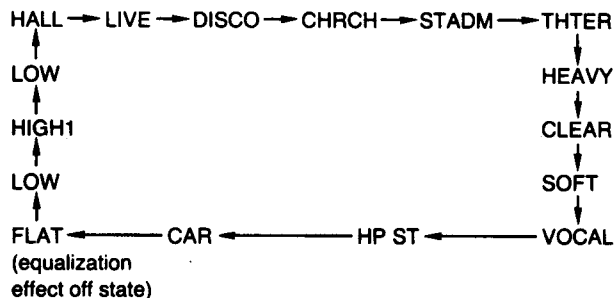

### ■ To select the desired sound mode

**Press the demonstration button.**

The demonstration function is cancelled, and the sound will be heard with the sound mode displayed when the demonstration button is pressed.

### ■ To cancel the demonstration

**Press any button other than the demonstration button.**

The demonstration function is cancelled, and the sound will be heard with the sound mode previously set before the demonstration button is pressed.

## To retrieve equalization curves pre-programmed to this unit

This unit has been pre-programmed with six types of typical equalization curves. (See page 60.)

### Have you switched on the power?

**Is the SFP indicator in the off condition?**

If the SFP indicator illuminates, press the SFP OFF/ON button to go off the indicator before continuing.

This function can also be performed from the remote control. Follow the procedure described below.

(While playing the desired source,)

- 1 Press the equalizer ON/FLAT button to ON.**  
The equalizer on display will appear.

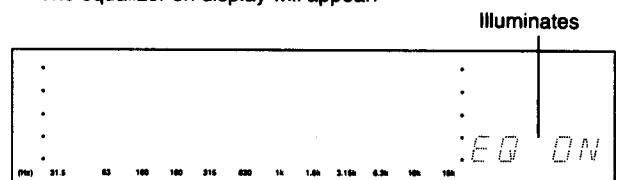

- 2 Press the fixed mode select button to select the desired equalization curve.**

Each press of the fixed mode select button advances the equalization curve setting in the following sequence. About the types of the equalization curves, see page 60.

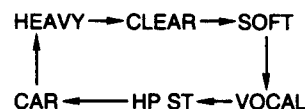

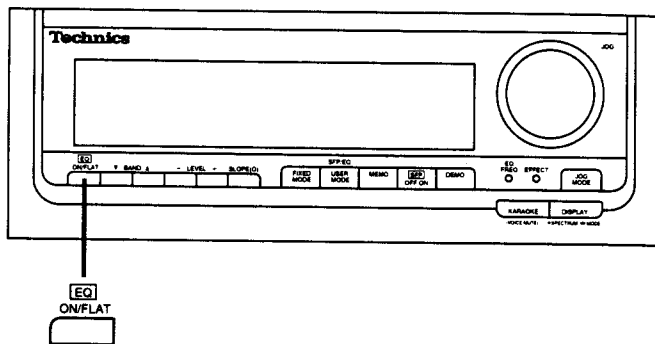

■ **To bypass the graphic equalizer**

This function can also be performed from the remote control. Follow the procedure described below.

**Press the equalizer ON/FLAT button to select FLAT.**



The equalizer flat display will appear.

# Creating Your Own Sound (continued)

## About equalization curves pre-programmed to this unit

### 1 HEAVY

This curve can be used to add "punch" to rock and other music.

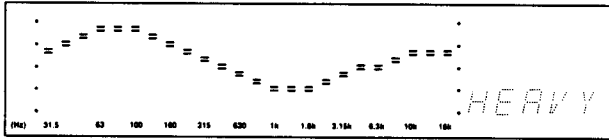

### 2 CLEAR

This curve can be used to clarify the treble range of jazz, etc.

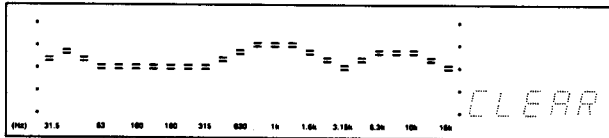

### 3 SOFT

This curve can be used to listen to background music, etc. at a low volume level.

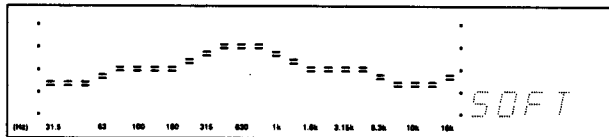

### 4 VOCAL

This curve can be used to clarify vocal music.

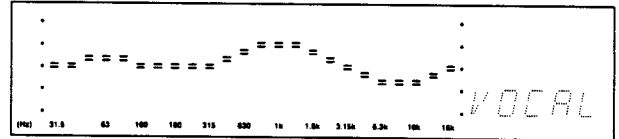

### 5 HP ST (Headphones stereo)

This curve can be used to make tape recording at optimum state for playback using the stereo cassette player.

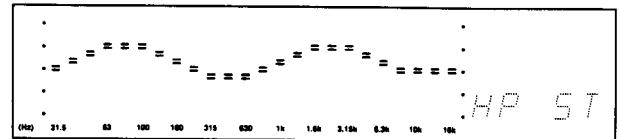

### 6 CAR (Car stereo)

This curve can be used to make tape recording at optimum state for playback using the car audio system.

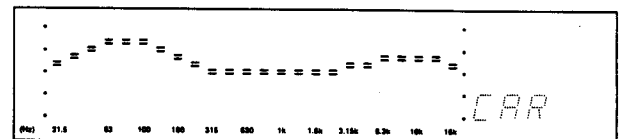

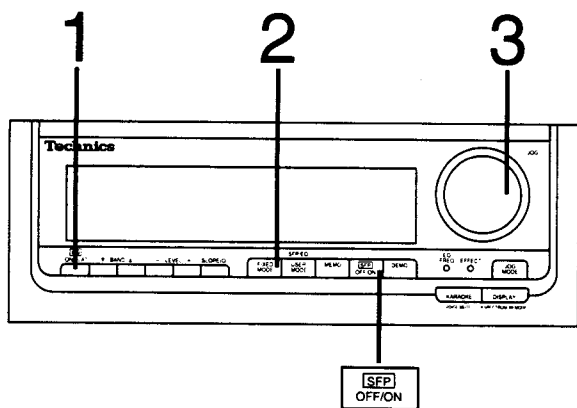

### To adjust the level of the equalization curves

The level of the pre-programmed equalization curves can be adjusted in 7 steps using the sound effect level control. (After the adjustment has been done, the pre-programmed equalization curve itself cannot be affected.)

#### Have you switched on the power?

#### Is the SFP indicator in the off condition?

If the SFP indicator illuminates, press the SFP OFF/ON button to go off the indicator before continuing.

This function can also be performed from the remote control. Follow the procedure described below.

(While playing the desired source,)

- 1 Press the equalization ON/FLAT button to ON. The equalizer on display will appear.
- 2 Press the fixed mode select button to select the desired equalization curve.
- 3 Adjust the level of the equalization curve using the sound effect level control.

 : When increase the level

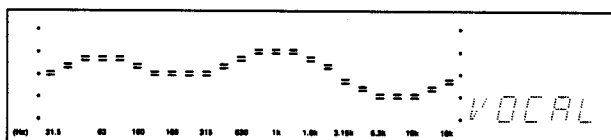

 : When decrease the level

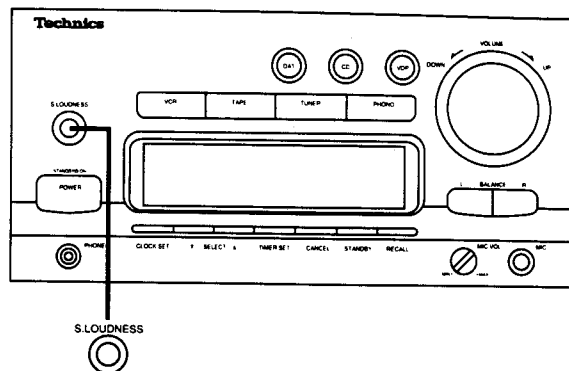
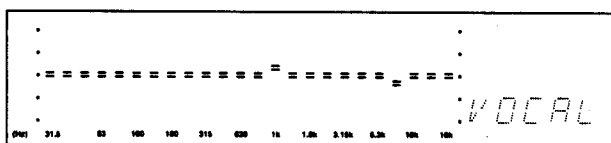

### To emphasize low-frequency sound

It is effective especially in a low volume level.

(While playing the desired source,)

**Press the loudness button on the amplifier to illuminate the loudness indicator.**

S.LOUDNESS

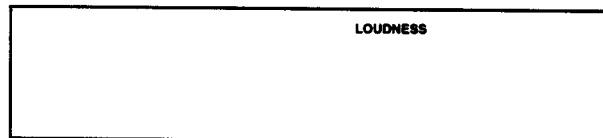

To cancel, press this button again to go off the indicator.

# Creating Your Own Sound (continued)

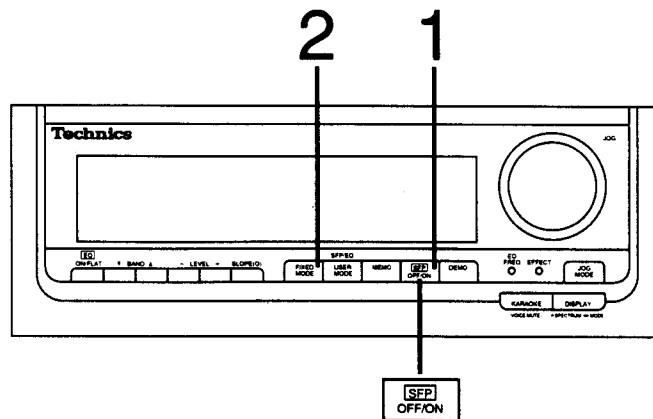

## To retrieve the surround sound modes pre-programmed to this unit

This unit has been pre-programmed with six types of surround sound. The surround sound system named SFP (Sound Field Processor) creates the effect that imparts presence and spread and thereby enhance and enrich the music. (See page 63.)

This function can also be performed from the remote control. Follow the procedures described below.

(While playing the desired source,)

### 1 Press the SFP OFF/ON button to ON.

The SFP indicator will illuminate.

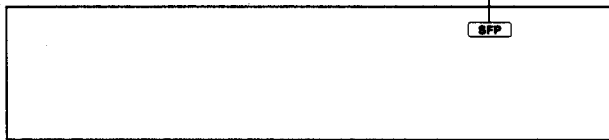

### 2 Press the fixed mode select button to select the desired surround sound mode.

Each press of the fixed mode select button advances the surround sound mode in the following sequence. (See page 63.)

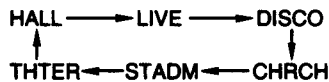

### ■ To cancel the surround sound mode

This function can also be performed from the remote control. Follow the procedure described below.

**Press the SFP OFF/ON button to go off the SFP indicator.**



## About the surround sounds pre-programmed to this unit

### 1 HALL

From classical to pop, to rock this function imparts a deep bass and spread which will make you feel as if you were in a large concert hall.

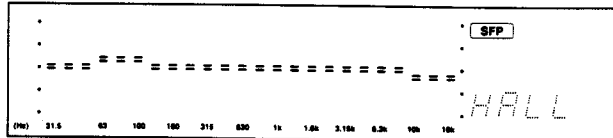

### 2 LIVE

Primarily for vocal pieces, this function adds gloss to the vocals and you'll feel as though you were hearing a live stage performance.

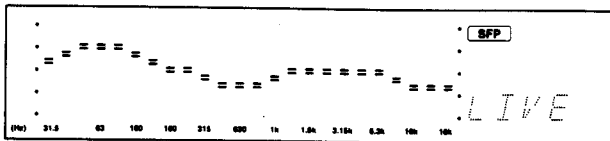

### 3 DISCO

Especially designed for listening to disco music selections. It creates the long reverberations and powerful bass sounds found in discos.

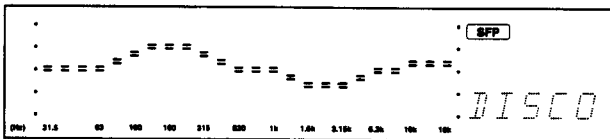

### 4 CHRCH (CHURCH)

When listen to the sound of the pipe organ, harpsichord, etc., this mode is most effective to create the rich reverberations as if you were in the church.

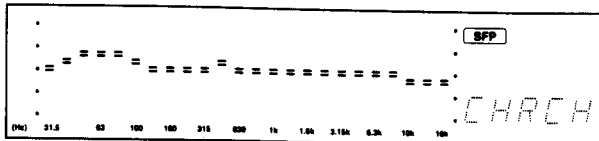

### 5 STADM (STADIUM)

When listening to baseball or football relay broadcasts, this function automatically sets the appropriate bass level for the announcer's voice (mono) and audience cheers (stereo).

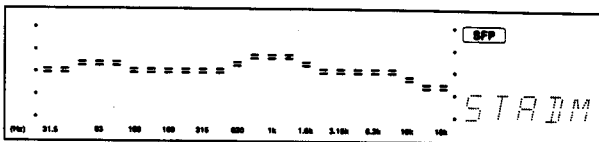

### 6 THTER (THEATER)

This mode is effective for the movie soft. Powerful and dynamic sound space available in the movie theater can be realized.

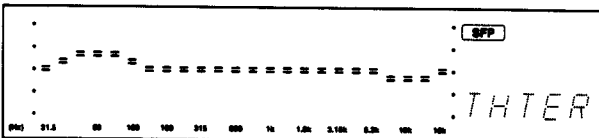

# Creating Your Own Sound (continued)

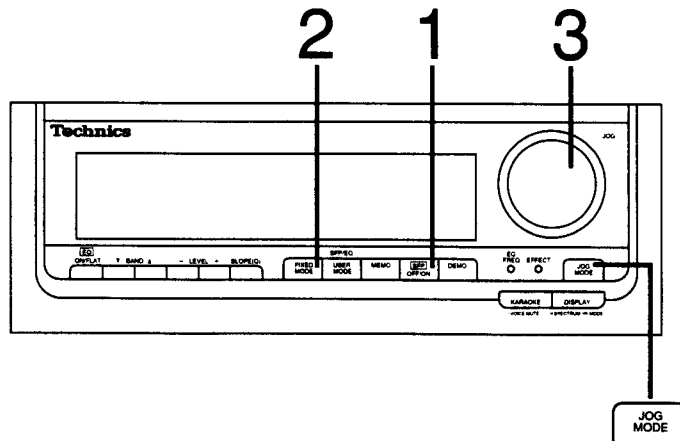

## To adjust the reverberation sound effect

The reverberation sound of the surround sound modes (SFP) can be adjusted using the sound effect level control. (The pre-programmed surround sound itself cannot be affected after the adjustment has been done.)

This function can also be performed from the remote control. Follow the procedures described below.

(While playing the desired source,)

- 1 Press the SFP OFF/ON button to ON. The SFP indicator will illuminate.
- 2 Press the fixed mode select button to select the desired surround sound mode.
- 3 Adjust the level using the sound effect level control.

: When increase the effect

: When decrease the effect

The reverberation sound and the equalization curve are automatically adjusted at the same time.

The reverberation sound display

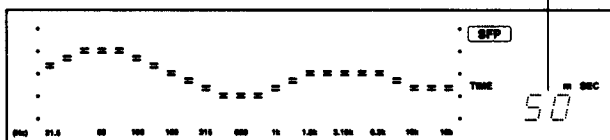

The reverberation sound can be adjusted within the range described below.

Mode	Possible ranges
HALL	1.2-3.2 sec.
LIVE	10-50 m sec.
DISCO	0.5-2.5 sec.
CHRCH	3.5-5.5 sec.
STADM	30-130 m sec.
THTER	10-30 m sec.

■ To adjust the equalization curve after above adjustment has been done

Press the jog mode button to illuminate the equalizer frequency indicator, and then proceed to the step 1 on page 65.



### Note:

While the "USER" illuminates, the reverberation sound with equalization effect can not be adjusted.



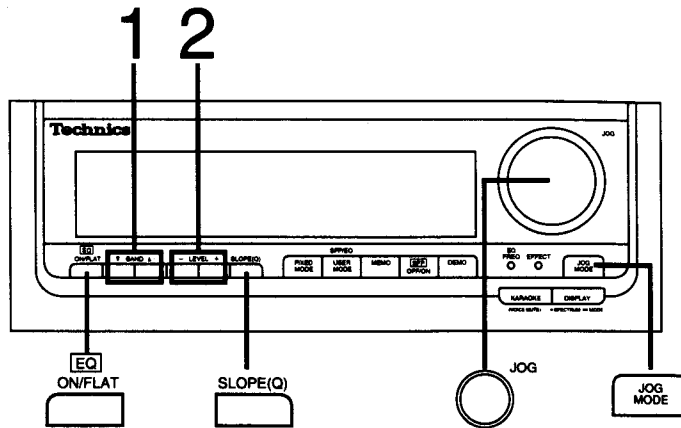

## To adjust the level of the specific frequency

With this system the frequency of interests can be freely selected with equalizer frequency select buttons, matching it with the music source, and you can enjoy sound as you like it. Furthermore, this unit has a built-in constant Q circuit so it has minimum effect on adjacent frequencies because the curve slope (Q) is large and very fine adjustment is possible.

Before continuing, select the desired equalization curve and/or surround sound mode. (See page 58 and 62.)

(While playing the desired source,)

### 1 Press one of the equalizer frequency select buttons to select the desired frequency.

Each time one of the equalizer frequency select buttons is pressed, LOW, HIGH1, HIGH2 will be alternately displayed.

LOW: 31.5–220 Hz range  
 HIGH1: 315 Hz–16 kHz range  
 HIGH2

### 2 Press one of the equalizer level control buttons to adjust the frequency level.

 : When increase the level

 : When decrease the level

### ■ To change the curve slope

The curve slope selection changes from “narrow” mode to “wide” mode and vice versa each time the slope (Q) select button is pressed.

Press the slope (Q) select button.

SLOPE(Q)  



In the “wide” mode the adjacent cursors will be boosted more than while in the “narrow” mode.

### ■ To shift the curve slope

The curve slope can be shifted within the range of 31.5–220 Hz or 315 Hz–16 kHz.

Shift the curve slope using the sound effect level control.

 : When shift the curve slope from the low frequency sound to the high frequency sound.

 : When shift the curve slope from the high frequency sound to the low frequency sound.

### ■ To adjust the reverberation sound after the above settings have been done

Press the jog mode button to illuminate the effect indicator, and then proceed to the step 3 on page 64. (When the SFP indicator illuminates,)

### ■ To bypass the graphic equalizer

(When the SFP indicator illuminates,)

Press the equalizer ON/FLAT button to select FLAT.

The “USER” display will illuminate.



### Note:

The curve slope cannot be shifted within the range from 31.5–220 Hz to 315 Hz–16 kHz. That can not also be shifted from 315 Hz–16 kHz to 31.5–220 Hz.

# Creating Your Own Sound (continued)

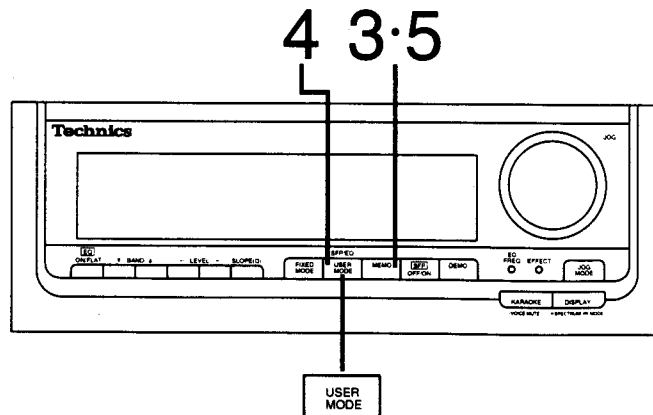

## To store the desired equalization curves and/or surround sound (USER mode)

Up to 5 types of sound quality can be memorized.

- 1 Select the desired equalization curve or surround sound mode.  
(See page 58 and 62.)
- 2 Adjust the selected equalization curve and/or surround sound mode.  
(See page 61 and 64-65.)
- 3 Press the memory button.  
The "MEMO" will appear on the display.

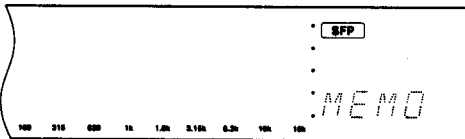

- 4 Press the user mode select button to select the desired memory number.  
Each time this button is pressed, the display will change as follows.

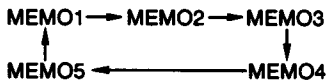

- 5 Press the memory button.  
The memory number you select will be displayed as a "USER" number.

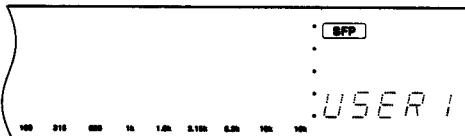

## To retrieve the USER mode from the memory

Press the user mode select button to select the desired memory number.



### Notes:

- The previous setting memorized in a number will be cancelled if a new setting has been memorized in that number.
- The memory will be maintained for as long as approximately 2 weeks even if the unit is in the standby mode.

# Enjoying the Microphone Mixing

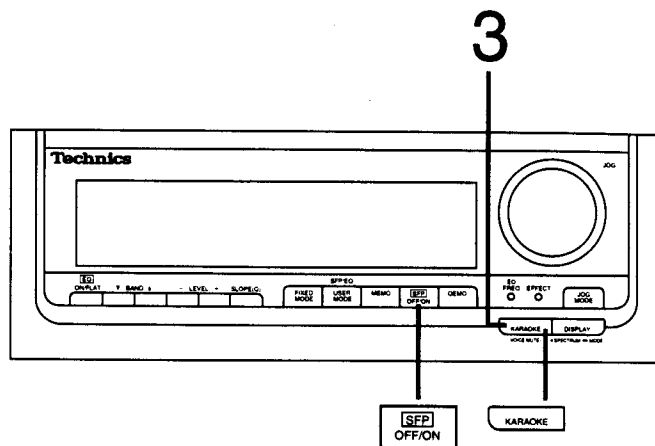

## Using the "KARAOKE" function

### Have you switched on the power?

This function attenuates only the singing voice in the tune, so you can easily enjoy karaoke (singing with an accompaniment) with compact discs. You can also make an adjustment of the key and/or the reverberation sound effect.

- 1 Connect the microphone to the MIC jack on the amplifier.
- 2 Press the input select button marked "CD" on the amplifier, and start playing a compact disc.
- 3 Press the voice mute button and start microphone mixing.

The voice mute indicator will illuminate, and the singing voice is mixed with the sound.

Illuminates

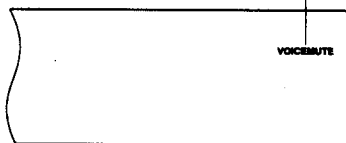

- 4 Adjust the microphone level using the microphone volume control on the amplifier.

### ■ To cancel the karaoke function

Press the voice mute button to go off the voice mute indicator.



### ■ To use the karaoke function with surround sound effect

Press the SFP OFF/ON button to illuminate "SURND" (surround).



# Enjoying the Microphone Mixing

(continued)

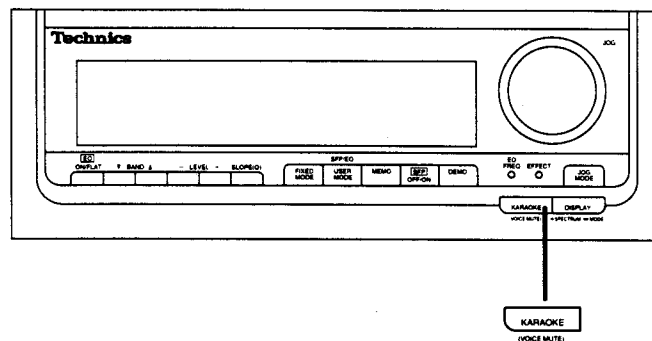

## ■ To use the karaoke source

Press the voice mute button to go off the voice mute indicator.



## ■ To make a mixing recording with karaoke function

Start recording in deck 2, and then start microphone mixing with the procedures described on page 67.

To playback the tape recorded with karaoke function, press the voice mute button to turn off the voice mute indicator.

### Notes:

- This function may not be effective according to the types of the tune.
- If strange noises (Squealing or howling) are emitted during mixing, keep the microphone far away from the speakers, or turn down the volume.
- When not using the microphone, disconnect the microphone from the MIC jack, and turn down the microphone volume level to MIN.
- This function cannot be used with the compact disc of monaural source. When using such source, press the voice mute button to go off the voice mute indicator.

# Using an External Unit

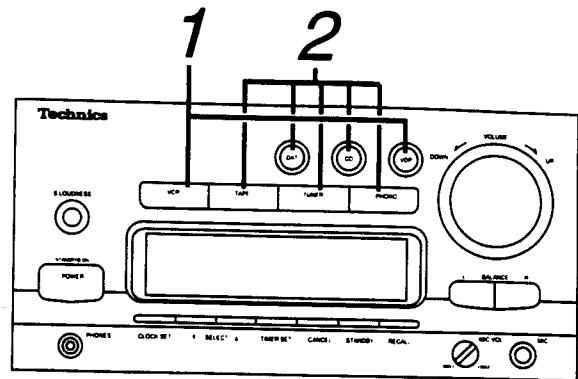
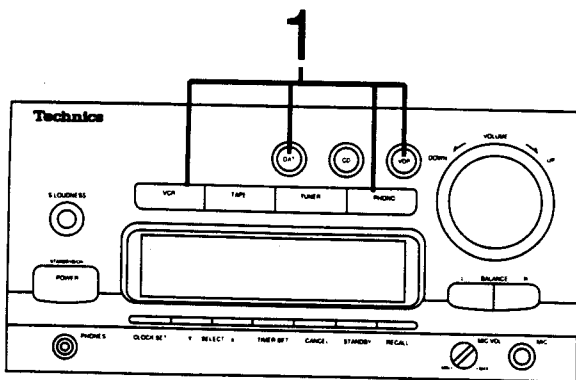

## To enjoy an external source

- 1 Press one of the input select buttons to select the external source connected to this unit. The selected source will be displayed.  
For example: VDP

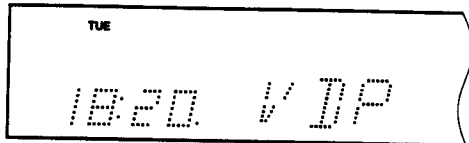

- 2 Operate the selected unit.  
See the instruction manual of the unit concerned for operating instructions.

### ■ To record on a DAT tape or a video cassette tape

After selecting the desired source, follow the procedures above, and then start recording.  
For details, refer to the DAT or the video deck instruction manual.

## To enjoy BGV (Back Ground Visual)

You can listen to a desired audio source while watching video picture and so on.

- 1 Press one of the input select buttons to select the desired video source (video deck, video disc player), and start playing.  
The selected source will be displayed.  
For example: Video deck

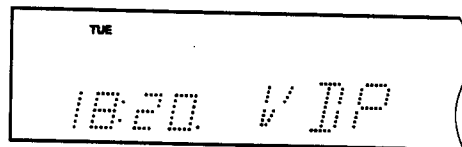

- 2 Press one of the input select buttons to select the desired audio source, and start playing.

The BGV indicator will illuminate.

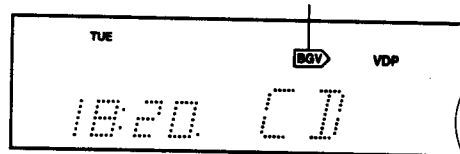

- To record the audio source on a video tape  
After following above procedures, start recording on a video deck.

# Concerning the Display

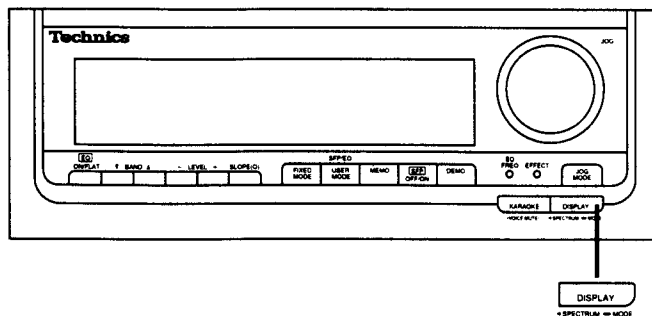

## About the spectrum display

The spectrum analyzer shows the level of each sound range with three types of display described below.

Press the display mode select button momentarily.



The spectrum display will change as follows.

### 1 Bar-type display

This display indicates the strength of the sound in each tonal range.

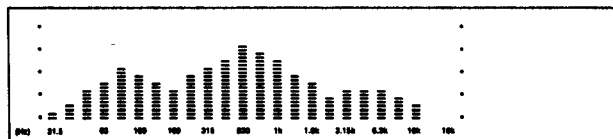

### 2 Peak-hold display

The peak sound value of each sound range is held on the display for about one second after occurs.

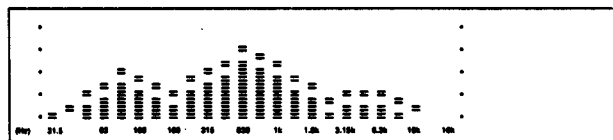

### 3 Aurora display

The peak sound value of each sound range is displayed in inverted form.

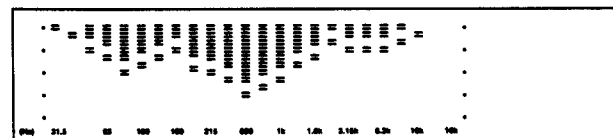

■ To display the equalization curve together with the spectrum analysis display

Press and hold the display mode select button.



The equalization curve will be displayed together with the spectrum analysis display.

To cancel, press and hold the button once again.

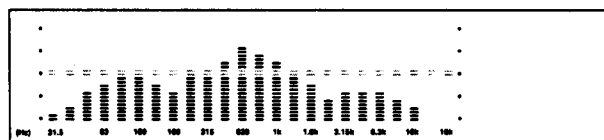

# Concerning Cassette Tapes

## Selection of cassette tapes

Do not use the following types of tapes in this unit.

### ● 120-minute (or longer) tapes

Because the tape is very thin, it might stretch during use causing unstable tape movement which may result in the tape becoming tangled in the rotating parts of this unit.

### ● Fe-Cr tapes (TYPE III)

The high frequency range will be emphasized and it will not be possible to obtain a flat frequency response.

### ● Metal tape without detection holes in the cassette

Recordings will be very distorted. (There is no playback problem, however.)

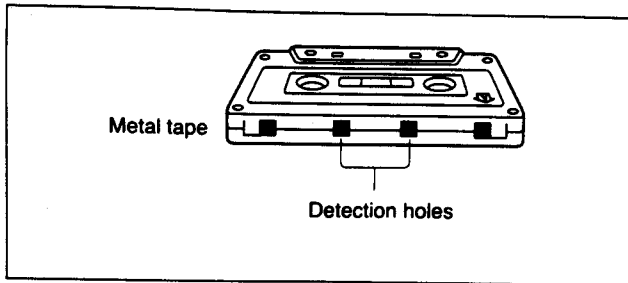

## Tape slack

Tape slack may cause the tape to break.

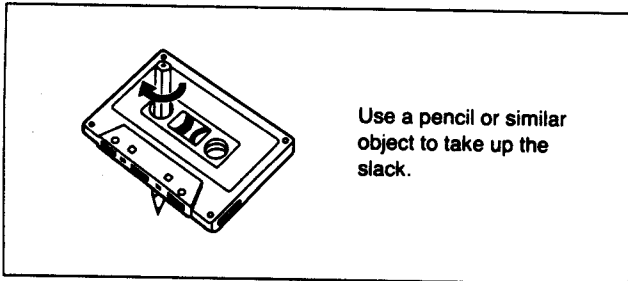

## To prevent erasure of recorded sounds

Remove the erase-prevention tabs (thus preventing recording).

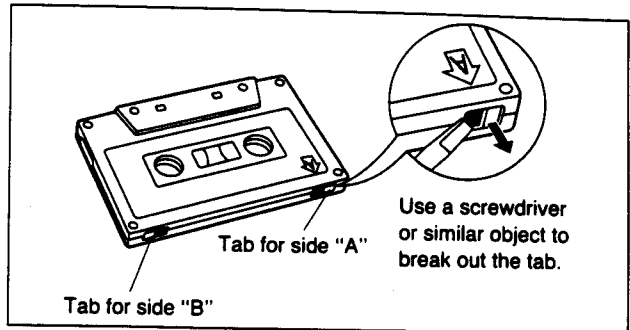

## ■ To re-record on a protected cassette

Cover the slot with adhesive tape.

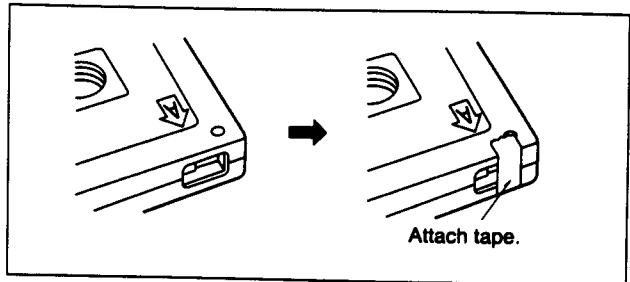

## Avoid tape storage in the following places

Tape can be damaged if it is stored in places such as described below.

- Where the temperature is high (95°F/35°C or higher) or where the humidity is high (80% or higher).
- Where there is a strong magnetic field (near a speaker, on top of a TV, etc.). Recording may become erased.
- In direct sunlight.

# Concerning Compact Discs

Only compact discs having this mark can be used with this unit.



## Handling precautions

To open the case, gently press the sides of the top, holding the top at both sides.

To remove the disc from the case, press the center holder and lift the disc holding by the edges.

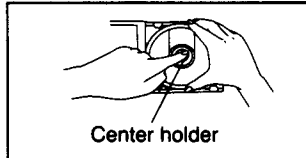
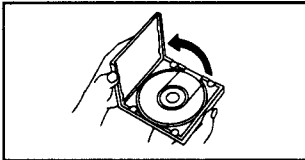

To store the disc to the case, insert the disc with label facing up and press downward at the center.

Hold the compact discs by the edges so the surface is not soiled with fingerprints. Fingerprints, dirt and scratches can cause skipping and distortion.

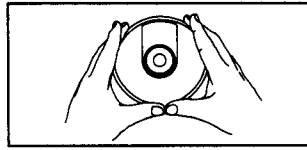
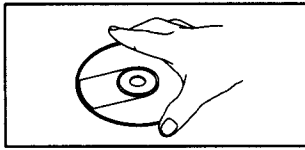

Do not use record cleaning sprays, benzene, thinner, static electricity prevention liquids or any other solvent.

If the surface is soiled, wipe gently with a soft, damp (water only) cloth.

Always move the cloth directly outward from the center of the disc, not in a circular motion as with standard phonograph records.

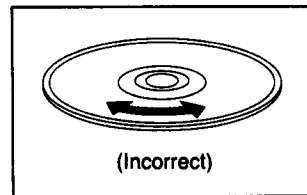
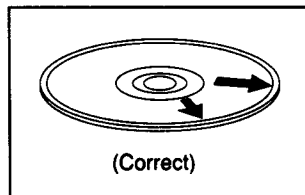

If the disc is brought from a cold to a warm environment moisture may form on the disc. Wipe this off with a soft, dry, lint-free cloth before using the disc.

Do not write on the label side with a ball-point pen or other writing utensil.

## Storage precautions

Be sure to store discs in their cases to protect them from dust, scratches and warping.

Do not place or store discs in the following places:

- 1) Locations exposed to direct sunlight.
- 2) Humid or dusty locations.
- 3) Locations directly exposed to a heat outlet or heating appliance.
- 4) In the glove compartment or rear ledge of an automobile.



# Maintenance

## Head care

To assure good sound quality for recording and playback, be sure to clean the heads after approximately every 10 hours of use.

1. Switch the power of this unit to standby mode.
2. Press the eject button to open the cassette holder.
3. Clean the heads, pinch roller and the capstan shaft of each deck with a cotton swab (or with a soft, lint-free cloth) slightly moistened with alcohol.

Do not use any solution other than alcohol for head cleaning.

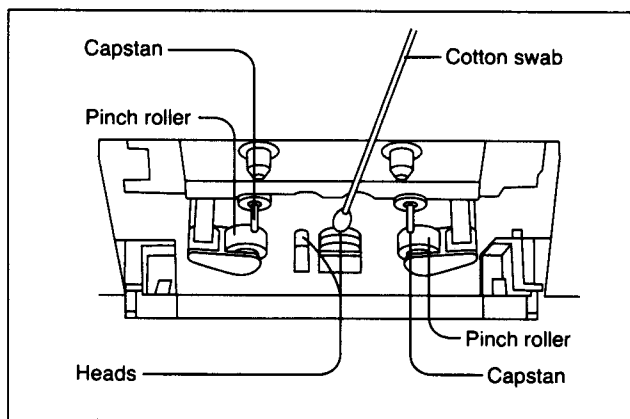

## Head demagnetization

In order to maintain good sound quality during recording and playback, it is recommended that the heads should be demagnetized if distortion or poor sound quality persist after cleaning the heads.

If the heads become magnetized, they could create noise in recordings, loss of high-frequency response, or erasure of valuable recordings. Several types of head demagnetizers are available and may be purchased at local electronics supply stores. Follow the instructions that are supplied with the device.

- Do not bring any type of metal objects or tools such as magnetic screwdrivers in contact with the head assembly.

## Maintenance of external surfaces

To clean this unit, use a soft, dry cloth.

For very dirty surfaces, dip a soft cloth in a weak soap-and-water solution and wring well. After cleaning, wipe with a soft, dry cloth. Never use alcohol, paint thinner, benzine, or a chemically treated cloth to clean this unit.

Such chemicals may damage the unit's finish.

# Troubleshooting Guide

Before requesting service for this unit, check the chart below for a possible cause of the problem you are experiencing. Some simple checks or a minor adjustment on your part may eliminate the problem and restore proper operation.

If you are in doubt about some of the check points, or if the remedies indicated in the chart do not solve the problem, refer to the directory of Authorized Service Centers (enclosed with this unit) to locate a convenient service center, or consult your dealer for instructions.

Problem	Probable cause(s)	Suggested remedy
---------	-------------------	------------------

Problems common to all units		
No sound is emitted when the power is switched ON.	"--" appears on the volume level display.	Adjust the volume level with the volume control on the amplifier.
The location of the various musical instruments is not well defined.	Reverse the (+) and (-) connections to one of the speakers.	Connect the speaker cord correctly.
The left and right sounds are reversed.	Reverse the left and right connections to the speaker.	Connect the speaker cord correctly.
A low frequency hum is heard when a source is being played.	The power cord or a fluorescent light is located near a connecting cord.	Keep electrical appliances well away from the connecting cords.
Sound is emitted from only one speaker.	One of the wires of the speaker cord is disconnected.	Connect the speaker cord correctly.
No sound is emitted when a source is being played.	The (+) and (-) wires of the speaker cords are shorted.	Switch the system to standby mode, re-connect the speaker cords so that it is not shorted, then switch the power ON again.

While listening to FM broadcasts		
A "rushing" noise which is not heard during a monaural broadcast is heard during a stereo broadcast.	Noise is more likely to appear on a stereo signal than on a monaural signal.	<ul style="list-style-type: none"> <li>• If an indoor antenna is being used, change to an outdoor antenna.</li> <li>• If a special outdoor antenna is being used, try changing the installation location, height, and orientation.</li> <li>• Try switching off the television or video deck.</li> <li>• Press the FM mode button on the remote control to change the reception from stereo to monaural mode.</li> </ul>
Much noise is heard during a stereo broadcast, and occasionally the sound from the program disappears.	The installation location and orientation of the antenna are unsuitable. The transmitting station is a long distance away.	
The stereo indicator of the tuner flickers and does not light completely.		
The sound during a stereo broadcast is highly distorted.	There is a building or mountain nearby. [Distortion is caused by interference between the signal from the transmitting station (direct wave) and the signal reflected from the building or mountain (reflected wave).]	

While listening to MW/LW broadcasts		
An unusual beat sound is heard.	The system is being used at the same time as a television set.	Switch off the television set, or use the system farther away from the television set.
A low frequency hum is heard.	The antenna wire is near the power cord.	Separate the antenna wire from the power cord.

When there is a television set nearby		
The picture disappears or stripes can be seen.	The location and orientation of the antenna are incorrect.	<ul style="list-style-type: none"> <li>• If an indoor antenna is being used, change to an outdoor antenna.</li> <li>• Separate the television set from the system.</li> </ul>
	The wiring at the back of the system is unsuitable.	Separate the antenna wire of the television set from the system.

Problem	Probable cause(s)	Suggested remedy
---------	-------------------	------------------

### While using the tape decks

Sound is low, intermittent, of poor quality, noisy, scratchy, or unsteady.	Heads are dirty.	Clean the heads.
	The Dolby noise reduction button is set in the wrong position.	Set it to match the recording condition.
The deck section does not enter the recording mode.	The erase-prevention tabs have been removed.	Attach tape to cover the space left by removal of the erase-prevention tabs.

### While listening to compact disc

The tray does not close when a disc is loaded and the disc tray open/close button is pressed.	The disc is not sitting correctly in the disc tray.	Re-locate on the tray.
	The disc is loaded upside down.	Re-load the disc.
	The disc is dirty.	Wipe the disc with a soft cloth.
	The disc is badly warped.	Replace the disc with a new one.
	The disc used is a non-standard one.	Replace the disc with a different one.
	There is condensation inside the compact disc player.	Switch ON the power, then wait for 20 to 30 minutes before using it.
A certain part of the disc cannot be played.	The disc is dirty.	Clean the disc with a soft cloth.
	The disc is scratched.	Skip the scratched part of the disc (skip play).

### While using the sound processor

The equalization curve cannot be adjusted.	Equalizer ON/FLAT button is set to FLAT.	Press the equalizer ON/FLAT button to set to "EQ ON".
--	--	---

### While using the remote control

The system cannot be operated with the remote control.	The batteries are installed in the reverse polarity.	Re-insert the batteries in the correct polarity.
	The batteries are worn.	Replace the batteries with new batteries.

# Technical Specifications

(DIN 45 500)

## Tuner/CD Player

### FM TUNER SECTION

<b>Frequency range</b>	87.50–108.00 MHz (0.05 MHz step)
<b>Sensitivity</b>	1.5 $\mu$ V (IHF, usable)
<b>S/N 30 dB</b>	1.5 $\mu$ V (75 $\Omega$ )
<b>S/N 26 dB</b>	1.3 $\mu$ V (75 $\Omega$ )
<b>S/N 20 dB</b>	1.2 $\mu$ V (75 $\Omega$ )
<b>IHF 46 dB stereo quieting sensitivity</b>	28 $\mu$ V (75 $\Omega$ )
<b>Total harmonic distortion</b>	
<b>MONO</b>	0.2%
<b>STEREO</b>	0.3%
<b>S/N</b>	
<b>MONO</b>	60 dB (74 dB, IHF)
<b>STEREO</b>	58 dB (70 dB, IHF)
<b>Frequency response</b>	20 Hz–15 kHz, +0.5––2.0 dB
<b>Alternate channel selectivity <math>\pm</math>400 kHz</b>	70 dB
<b>Stereo separation 1 kHz</b>	35 dB
<b>Channel balance 250 Hz–6300 Hz</b>	$\pm$ 1.5 dB
<b>Limiting point</b>	1.2 $\mu$ V
<b>Band width</b>	
<b>IF amplifier</b>	180 kHz
<b>FM demodulator</b>	1000 kHz
<b>Antenna terminals</b>	75 $\Omega$ (unbalanced)

### MW/LW TUNER SECTION

<b>Frequency range</b>	
<b>MW</b>	522–1611 kHz (9 kHz step)
<b>LW</b>	144–288 kHz (9 kHz step)
<b>Sensitivity (S/N 20 dB)</b>	
<b>MW</b>	20 $\mu$ V, 330 $\mu$ V/m
<b>LW</b>	50 $\mu$ V
<b>Selectivity (<math>\pm</math>9 kHz)</b>	
<b>MW (at 999 kHz)</b>	50 dB
<b>LW (at 216 kHz)</b>	50 dB

### CD PLAYER SECTION

<b>Pick up</b>	
<b>Beam source</b>	780 nm Semiconductor laser
<b>Type</b>	1 beam
<b>Spindle motor</b>	DC motor

### GENERAL

<b>Dimensions (W×H×D)</b>	215×83×290 mm
<b>Weight</b>	2.0 kg

## Amplifier

### MAIN AMP. SECTION

<b>Power output</b>	
<b>DIN 1 kHz THD 1%, both channel driven</b>	2×40 W (6 $\Omega$ )
<b>Total harmonic distortion</b>	
<b>Rated power at 1 kHz</b>	1% (6 $\Omega$ )
<b>Half power at 1 kHz</b>	0.09% (6 $\Omega$ )
<b>Headphones output level/impedance</b>	335 mV/240 $\Omega$
<b>Load impedance</b>	
<b>MAIN</b>	6 $\Omega$
<b>SURROUND</b>	8 $\Omega$

### PRE AMP. SECTION

<b>Input sensitivity/impedance</b>	200 mV/47 k $\Omega$
<b>MIC</b>	0.7 mV/12 k $\Omega$
<b>S/N (rated power)</b>	84 dB (IHF, A 88 dB)
<b>Frequency response</b>	30 Hz–30 kHz (–3 dB)
<b>Muting</b>	–20 dB
<b>Loudness (vol. –30 dB)</b>	60 Hz, +5 dB
<b>Channel separation (1 kHz)</b>	57 dB

### TIMER SECTION

<b>Clock</b>	Quartz-lock type, 24-hour indication
<b>Functions</b>	24-hour programmable; Weekly (1 time), Sleep 120 min. (1 min. intervals)
<b>Setting</b>	1 minute–23 hours 59 minutes (1 min.)

### GENERAL

<b>Power consumption</b>	250 W
<b>Power supply</b>	AC 50/60 Hz, 230–240 V
<b>Dimensions (W×H×D)</b>	215×110×346 mm
<b>Weight</b>	5.1 kg

## Sound Processor

### PRE AMP. SECTION

<b>Input sensitivity/impedance</b>	
<b>PHONO</b>	2.5 mV/47 k $\Omega$
<b>VCR/VDP (input with RCA PIN)</b>	250 mV/18 k $\Omega$
<b>Total harmonic distortion</b>	
<b>–3 dB output at 1 kHz</b>	0.08%

### EQUALIZER, SOUND FIELD PROCESSOR SECTION

<b>Equalizer</b>	
<b>Center frequency</b>	
<b>LOW</b>	31.5, 40, 50, 63, 80, 100, 125 160, 220 (Hz)
<b>HIGH1, 2</b>	315, 450, 630, 800, 1k, 1.25k, 1.6 k, 2.2 k, 3.15 k, 4.5 k, 6.3 k, 8 k, 10 k, 12.5 k, 16 k (Hz)
<b>Level control</b>	
<b>LOW, HIGH1, 2</b>	$\pm$ 12 dB
<b>(Q) control</b>	
<b>Narrow</b>	1.8
<b>Wide</b>	0.7
<b>Fixed mode</b>	
<b>Equalizer (6 modes)</b>	HEAVY, CLEAR, SOFT, VOCAL HEADPHONE STEREO, CAR STEREO
<b>Sound Field Processor (6 modes)</b>	HALL, LIVE, DISCO, CHURCH STADIUM, THEATER

<b>Frequency response</b>	
<b>PHONO</b>	RIAA STANDARD CURVE (30 Hz–15 kHz) +1.0, –1.5 dB
<b>TUNER, TAPE, VCR CD, DAT, VDP</b>	15 Hz–20 kHz, –1 dB
<b>S/N</b>	
<b>PHONO</b>	64 dB (DIN)
<b>TUNER, TAPE, VCR</b>	85 dB (IHF, at full scale input, IHF A)
<b>CD, DAT, VDP</b>	71 dB (DIN)
<b>MONITOR</b>	90 dB (IHF, at full scale input, IHF A)
<b>VCR REC OUT</b>	93 dB
<b>Video output</b>	
<b>MONITOR</b>	1 Vpp/75 $\Omega$
<b>VCR REC OUT</b>	1 Vpp/75 $\Omega$

### GENERAL

<b>Dimensions (W×H×D)</b>	215×83×292 mm
<b>Weight</b>	1.65 kg

## Cassette Deck

<b>Track system</b>	Compact cassette stereo
<b>Tape speed</b>	4.8 cm/sec.
<b>Bias frequency</b>	80 kHz
<b>Heads</b>	
<b>DECK 2 (record/playback) (erasure)</b>	Permalloy head
<b>DECK 1 (playback)</b>	Double-gap ferrite head
<b>Motors</b>	
<b>DECK 2</b>	DC servo motor
<b>DECK 1</b>	DC servo motor
<b>Wow and flutter</b>	0.1% (WRMS)
<b>Fast forward and rewind time</b>	Approx. 110 sec. (C-60 tape)

<b>Frequency response (at CCRT ON)</b>	
<b>NORMAL</b>	20–17000 Hz
<b>CrO<sub>2</sub></b>	30–15000 Hz (DIN)
<b>METAL</b>	20–18000 Hz
<b>CrO<sub>2</sub></b>	30–17000 Hz (DIN)
<b>METAL</b>	20–20000 Hz
<b>CrO<sub>2</sub></b>	30–19000 Hz (DIN)

<b>S/N (CrO<sub>2</sub>)</b>	
<b>DOLBY off</b>	56 dB (A WTD, signal level: MOL)
<b>DOLBY B</b>	66 dB (CCIR)
<b>DOLBY C</b>	74 dB (CCIR)
<b>Input sensitivity</b>	
<b>LINE IN</b>	250 mV
<b>Output level</b>	
<b>LINE OUT</b>	400 mV
<b>Dimensions (W×H×D)</b>	215×110×279 mm
<b>Weight</b>	2.8 kg

## Speaker System

<b>Type</b>	3 way 3 speakers bass-reflex
<b>Speaker</b>	
<b>Woofer</b>	16 cm cone type
<b>Midrange</b>	6 cm cone type
<b>Tweeter</b>	horn type
<b>Impedance</b>	6 $\Omega$
<b>Input power (music)</b>	100 W
<b>Output sound pressure level</b>	88 dB/W (1.0 m)
<b>Cross over frequency</b>	2.5 kHz, 10 kHz
<b>Frequency range</b>	43 Hz–22 kHz (–16 dB)
<b>Dimensions (W×H×D)</b>	207×384×274 mm
<b>Weight</b>	5.4 kg

### Notes:

- Specifications are subject to change without notice. Weight and dimensions are approximate.
- Total harmonic distortion is measured by the digital spectrum analyzer.

# Memo

# Memo

# Memo

---

**Matsushita Electric Industrial Co., Ltd.**  
Central P.O. Box 288, Osaka 530-91, Japan

RQT1359-B